

# Agilent 2-Port PNA-L Network Analyzer

**N5234A 10 MHz to 43.5 GHz**

**N5235A 10 MHz to 50 GHz**

Data Sheet and  
Technical Specifications

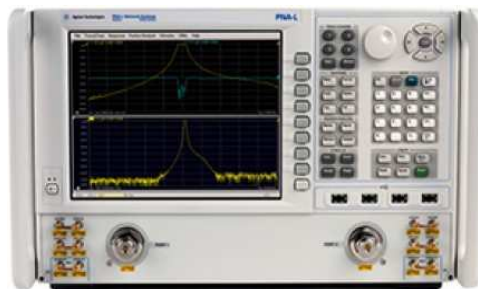
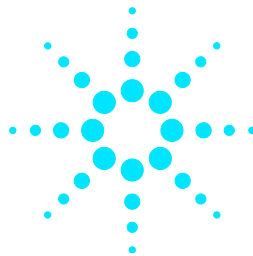

## **Documentation Warranty**

THE MATERIAL CONTAINED IN THIS DOCUMENT IS PROVIDED "AS IS," AND IS SUBJECT TO BEING CHANGED, WITHOUT NOTICE, IN FUTURE EDITIONS. FURTHER, TO THE MAXIMUM EXTENT PERMITTED BY APPLICABLE LAW, AGILENT DISCLAIMS ALL WARRANTIES, EITHER EXPRESS OR IMPLIED WITH REGARD TO THIS MANUAL AND ANY INFORMATION CONTAINED HEREIN, INCLUDING BUT NOT LIMITED TO THE IMPLIED WARRANTIES OF MERCHANTABILITY AND FITNESS FOR A PARTICULAR PURPOSE. AGILENT SHALL NOT BE LIABLE FOR ERRORS OR FOR INCIDENTAL OR CONSEQUENTIAL DAMAGES IN CONNECTION WITH THE FURNISHING, USE, OR PERFORMANCE OF THIS DOCUMENT OR ANY INFORMATION CONTAINED HEREIN. SHOULD AGILENT AND THE USER HAVE A SEPARATE WRITTEN AGREEMENT WITH WARRANTY TERMS COVERING THE MATERIAL IN THIS DOCUMENT THAT CONFLICT WITH THESE TERMS, THE WARRANTY TERMS IN THE SEPARATE AGREEMENT WILL CONTROL.

## **DFARS/Restricted Rights Notice**

If software is for use in the performance of a U.S. Government prime contract or subcontract, Software is delivered and licensed as "Commercial computer software" as defined in DFAR 252.227-7014 (June 1995), or as a "commercial item" as defined in FAR 2.101(a) or as "Restricted computer software" as defined in FAR 52.227-19 (June 1987) or any equivalent agency regulation or contract clause. Use, duplication or disclosure of Software is subject to Agilent Technologies' standard commercial license terms, and non-DOD Departments and Agencies of the U.S. Government will receive no greater than Restricted Rights as defined in FAR 52.227-19(c)(1-2) (June 1987). U.S. Government users will receive no greater than Limited Rights as defined in FAR 52.227-14 (June 1987) or DFAR 252.227-7015 (b)(2) (November 1995), as applicable in any technical data.

<b>Documentation Warranty</b> .....	<b>2</b>
<b>DFARS/Restricted Rights Notice</b> .....	<b>2</b>
Definitions .....	5
<b>Corrected System Performance</b> .....	<b>6</b>
System Dynamic Range and Receiver Dynamic Range .....	6
Table 1a. System Dynamic Range (dB), N5234A.....	7
Table 1b. System Dynamic Range (dB), N5235A.....	7
Table 2. Receiver Dynamic Range (dB), All Models, All Options - Typical .....	8
<b>N5234A and N5235A Corrected System Performance, All Options</b> .....	<b>8</b>
Table 3. 85056A Calibration Kit.....	9
Table 4. N4693A 2-Port Electronic Calibration Module.....	11
<b>Uncorrected System Performance</b> .....	<b>13</b>
Table 5a. Error Terms (dB), All Models, All Ports, All Options - Specifications .....	13
Table 5b. Error Terms (dB), All Models, All Ports, All Options - Typical .....	13
<b>Test Port Output</b> .....	<b>14</b>
Table 6. Frequency Information, All Options .....	14
Table 7a. Maximum Leveled Power (dBm), N5234A , All Ports <sup>1</sup> .....	14
Table 7b. Maximum Leveled Power (dBm), N5235A, All Ports <sup>1</sup> .....	14
Table 8. Power Level Accuracy (dB) at Nominal Power <sup>1</sup> , All Models, All Options, All Ports <sup>2</sup> .....	15
Table 9. Power Level Linearity <sup>1</sup> (dB), All Models, All Options, All Ports <sup>2</sup> - Specification .....	15
Table 10. Power Sweep Range (dB), All Models, All Ports <sup>1</sup> .....	15
Table 11. Nominal Power (Preset,dBm), All Ports <sup>1</sup> , All Options .....	16
Table 12. Power Resolution and Maximum/Minimum Settable Power, All Models, All Ports <sup>1</sup> .....	16
Table 13. 2 <sup>nd</sup> and 3 <sup>rd</sup> Harmonics at Max Specified Power (dBc) All Options, All Ports <sup>1</sup> - Typical .	16
Table 14. Non-Harmonic Spurs at Nominal Power (dBc), All Models,All Options - Typical.....	16
Table 15. Phase Noise (dBc/Hz), All Models, All Options - Typical .....	17
<b>Test Port Input</b> .....	<b>18</b>
Table 16. Noise Floor <sup>1</sup> (dBm) @ 10 Hz IFBW, All Models, All Ports.....	18
Table 17. 0.1 dB Receiver Compression at Test Port (dBm), All Models, All Options, All Ports - Typical .....	18
Table 18. Receiver Compression at Test Port Power, All Models, All Options, All Ports - Specification .....	19
Table 19a. Trace Noise <sup>1</sup> Magnitude (dB rms), All Models, All Options .....	19
Table 19b. Trace Noise <sup>1</sup> Phase (deg rms), All Models, All Options .....	19
Table 20. Reference Level Magnitude, All Models and Options - Specification .....	20
Table 21. Stability <sup>1</sup> , All Models, All Options - Typical.....	20
Table 22a. Damage Level, All Models, Option 200 - Typical .....	20
Table 22b. Damage Level, All Models, Option 216 - Typical.....	20
<b>Dynamic Accuracy</b> .....	<b>21</b>
Table 23. Dynamic Accuracy - Specification.....	21

Table 24. Group Delay <sup>1</sup> .....	24
<b>General Information</b> .....	<b>25</b>
Table 25. Miscellaneous Information .....	25
Table 26. Front Panel Information, All Options .....	25
Table 27. Rear Panel Information, All Options .....	26
Table 28. Analyzer Dimensions and Weight .....	28
Regulatory and Environmental Information .....	28
<b>Measurement Throughput Summary</b> .....	<b>29</b>
Table 29. Cycle Time (ms) for Measurement Completion, All Options - Typical .....	29
Table 30. Cycle Time vs. IF Bandwidth - Typical .....	30
Table 31. Cycle Time vs. Number of Points - Typical .....	31
Table 32. Data Transfer Times - Typical .....	32
<b>Specifications: Front-Panel Jumpers</b> .....	<b>33</b>
Table 33. Measurement Receiver Inputs (dBm), Option 216 - Typical .....	33
Table 34. Reference Receiver Inputs and Reference Source Outputs (dBm) - Typical .....	33
Table 35. Source Outputs (dBm) - Typical .....	34
Table 36. Coupler Inputs (dB) - Typical .....	34
<b>Test Set Block Diagrams</b> .....	<b>35</b>
N5234A and N5235A Option 200 (2-port base model) .....	35
N5234A and N5235A Option 216 .....	35
Receiver Block Diagram .....	36

**This is a complete list of the technical specifications for the N5234A and N5235A PNA-L network analyzers with the following options:**

#### **All Models**

**Option 200** - 2-port base model with standard test set.

**Option 216** - To base model, adds front-panel jumpers and source attenuators (extended power range).

**See block diagrams for all models and options beginning on page 35.**

#### **Definitions**

All specifications and characteristics apply over a 25 °C ±5 °C range (unless otherwise stated) and 90 minutes after the instrument has been turned on.

**Specification (spec.):** Warranted performance. Specifications include guardbands to account for the expected statistical performance distribution, measurement uncertainties, and changes in performance due to environmental conditions.

**Characteristic (char.):** A performance parameter that the product is expected to meet before it leaves the factory, but that is not verified in the field and is not covered by the product warranty. A characteristic includes the same guardbands as a specification.

**Typical (typ.):** Expected performance of an average unit which does not include guardbands. It is not covered by the product warranty. Typical values are produced by averaging the measured data across each frequency band.

**Nominal (nom.):** A general, descriptive term that does not imply a level of performance. It is not covered by the product warranty.

**Calibration:** The process of measuring known standards to characterize a network analyzer's systematic (repeatable) errors.

**Corrected (residual):** Indicates performance after error correction (calibration). It is determined by the quality of calibration standards and how well "known" they are, plus system repeatability, stability, and noise.

**Uncorrected (raw):** Indicates instrument performance without error correction. The uncorrected performance affects the stability of a calibration.

**Standard:** When referring to the analyzer, this includes no options unless noted otherwise.

#### **Notes**

This document provides technical specifications for the 85056A and N4693A calibration kits.

Please download our free Uncertainty Calculator from [http://www.agilent.com/find/na\\_calculator](http://www.agilent.com/find/na_calculator) to generate the curves for your calibration kit and PNA-L setup.

## Corrected System Performance

The specifications in this section apply for measurements made with the N5234A and N5235A PNA-L network analyzers with the following conditions:

- 10 Hz IF bandwidth
- No averaging applied to data
- Isolation calibration with an averaging factor of 8

## System Dynamic Range and Receiver Dynamic Range

- **System Dynamic Range** is defined as the specified source maximum output power (spec) minus the noise floor (spec).
- **Extended Dynamic Range at Direct Access Input** is defined as the specified source maximum output power (spec) minus the direct receiver access input noise floor (spec).
- **Receiver Dynamic Range** is defined as the test port compression at 0.1 dB (typical) minus the noise floor (typical).

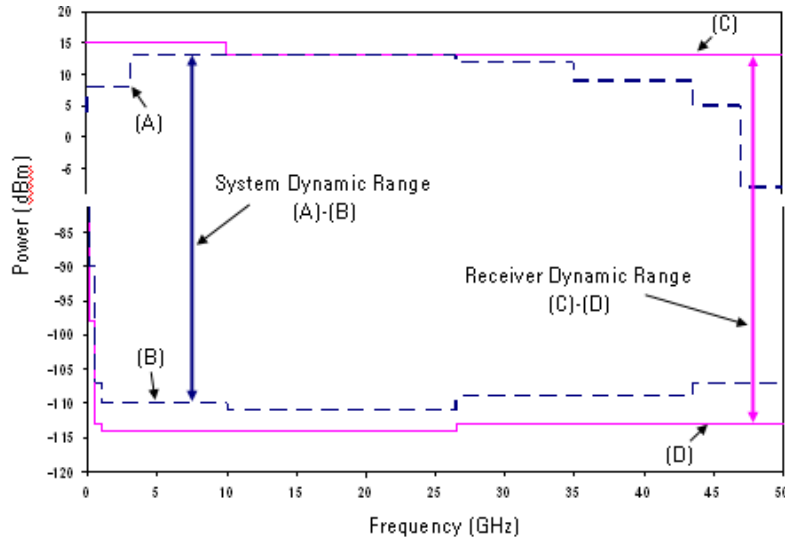

### NOTE:

The effective dynamic range must take measurement uncertainties and interfering signals into account.

The direct receiver access input extended dynamic range is calculated as the difference between the direct receiver access input noise floor and the source maximum output power. This set-up should only be used when the receiver input will never exceed its maximum receiver input. When the analyzer is in segment sweep mode, it can have predefined frequency segments which will output a higher power level when the extended dynamic range is required (i.e. devices with high insertion loss), and reduced power when the maximum receiver input level will occur (i.e. devices with low insertion loss). The extended range is only available in one-path transmission measurements.

It may typically be degraded at particular frequencies below 500 MHz due to spurious receiver residuals.

**Table 1a. System Dynamic Range (dB), N5234A**

Description	Specification			Typical		
	Option 200	Option 216		Option 200	Option 216	
	Test Port	Test Port	Direct Receiver Access port	Test Port	Test Port	Direct Receiver Access port
10 MHz to 45 MHz	75	75	110	94	94	138
45 MHz to 500 MHz	90	90	102	117	117	132
500 MHz to 2 GHz	110	110	122	129	129	144
2 GHz to 8.5 GHz	110	110	122	131	130	145
8.5 GHz to 12.5 GHz	110	110	122	132	131	146
12.5 GHz to 13.51 GHz	110	110	122	131	129	144
13.51 GHz to 20 GHz	100	100	112	120	118	133
20 GHz to 35 GHz	95	92	102	116	113	126
35 GHz to 40 GHz	95	92	102	116	113	126
40 GHz to 43.5 GHz	79	80	88	104	100	111

**Table 1b. System Dynamic Range (dB), N5235A**

Description	Specification			Typical		
	Option 200	Option 216		Option 200	Option 216	
	Test Port	Test Port	Direct Receiver Access port	Test Port	Test Port	Direct Receiver Access port
10 MHz to 45 MHz	75	75	110	94	94	138
45 MHz to 500 MHz	90	90	102	117	117	132
500 MHz to 2 GHz	110	110	122	129	129	144
2 GHz to 8.5 GHz	110	110	122	131	130	145
8.5 GHz to 12.5 GHz	110	110	122	132	131	146
12.5 GHz to 13.51 GHz	110	110	122	131	129	144
13.51 GHz to 20 GHz	100	100	112	120	118	133
20 GHz to 35 GHz	95	92	102	116	113	126
35 GHz to 40 GHz	95	92	102	116	113	126
40 GHz to 50 GHz	79	75	83	104	100	111

**Table 2. Receiver Dynamic Range (dB), All Models, All Options - Typical**

<b>Description</b>	<b>Typical</b>
10 MHz to 45 MHz	100
45 MHz to 500 MHz	120
500 MHz to 2 GHz	127
2 GHz to 8.5 GHz	128
8.5 GHz to 13.5 GHz	129
13.5 GHz to 20 GHz	117
20 GHz to 35 GHz	116
35 GHz to 40 GHz	114
40 GHz to 43.5 GHz	105
43.5 GHz to 47 GHz	104
47 GHz to 50 GHz	103

### **N5234A and N5235A Corrected System Performance, All Options**

Note: For any  $S_{ii}$  reflection measurement:

- $S_{jj} = 0$ .

For any  $S_{ij}$  transmission measurement:

- $S_{ji} = S_{ij}$  when  $S_{ij} \leq 1$
- $S_{ji} = 1/S_{ij}$  when  $S_{ij} > 1$
- $S_{kk} = 0$  for all  $k$

Applies to the N5234A/5A Option 200 or 216 analyzers, 85133F flexible test port cable set, and a full 2-port calibration.  
Also applies to the following condition:

Environmental temperature  $23^\circ \pm 3^\circ \text{C}$ , with  $< 1^\circ \text{C}$  deviation from calibration temperature

**Table 3. 85056A Calibration Kit**

Description	Specification (dB)						
	10 MHz to 50 MHz	50 MHz to 2 GHz	2 GHz to 10 GHz	10 GHz to 20 GHz	20 GHz to 30 GHz	30 GHz to 40 GHz	40 GHz to 50 GHz
Directivity	-42	-42	-42	-42	-38	-38	-36
Source Match	-41	-41	-38	-38	-33	-33	-31
Load Match	-42	-42	-42	-42	-37	-37	-35
Reflection Tracking <sup>1</sup>							
Mag	0.001	0.001	0.008	0.008	0.020	0.020	0.027
Phase (°/°C)	0.009	0.009	0.054	0.054	0.133	0.133	0.180
Transmission Tracking <sup>1</sup>							
Mag	0.019	0.019	0.051	0.060	0.129	0.129	0.220
Phase (°/°C)	0.126	0.126	0.335	0.393	0.848	0.848	1.453

<sup>1</sup>Temperature deviation is a characteristic value.

**Transmission Uncertainty, All Options**

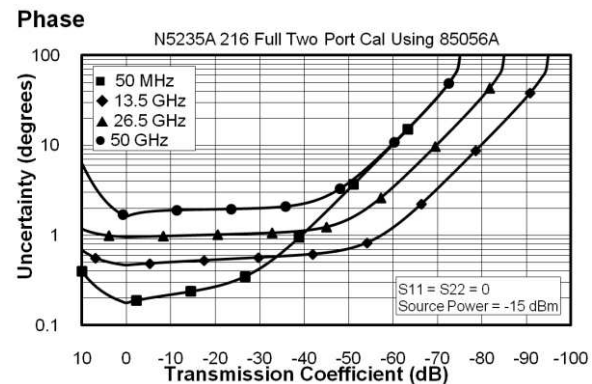
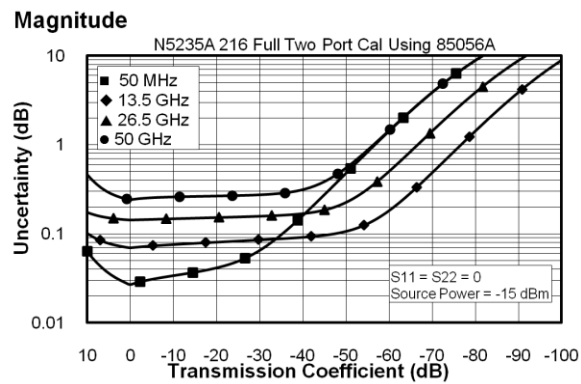
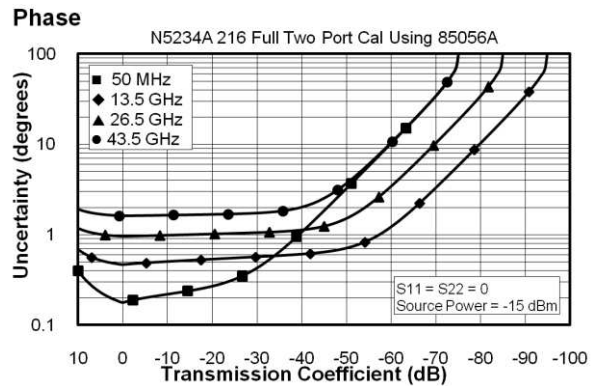
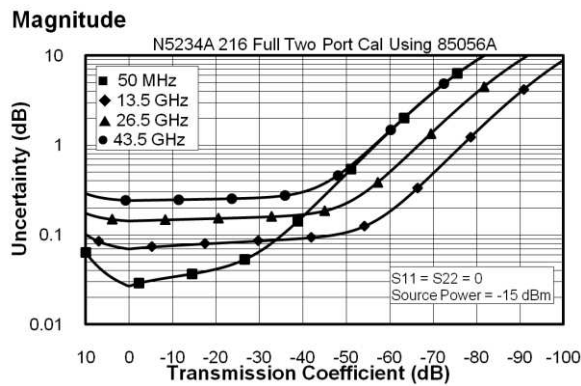

## Reflection Uncertainty, All Options

### Magnitude

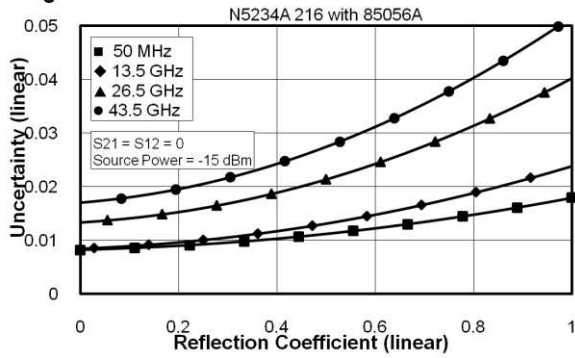

### Phase

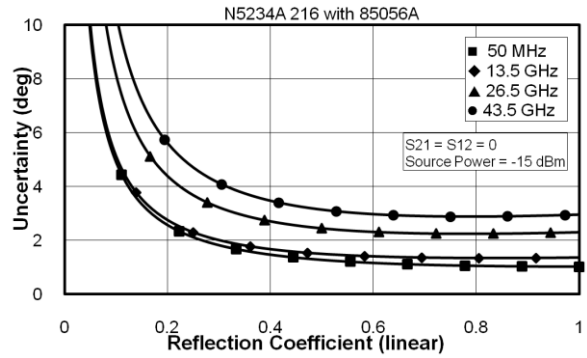

### Magnitude

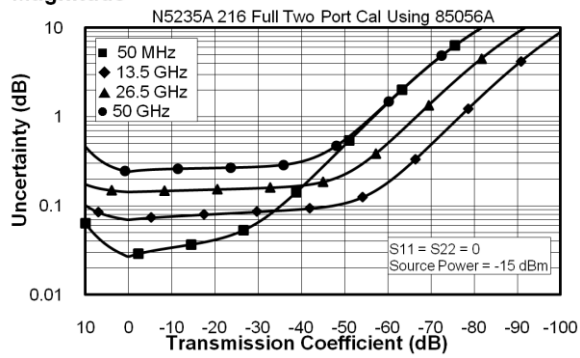

### Phase

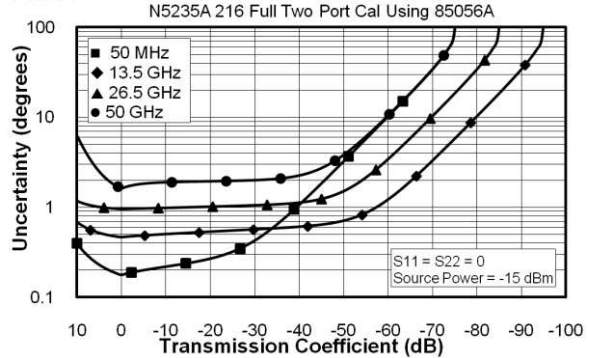
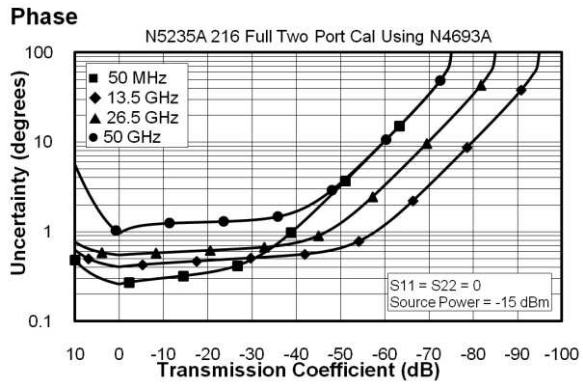
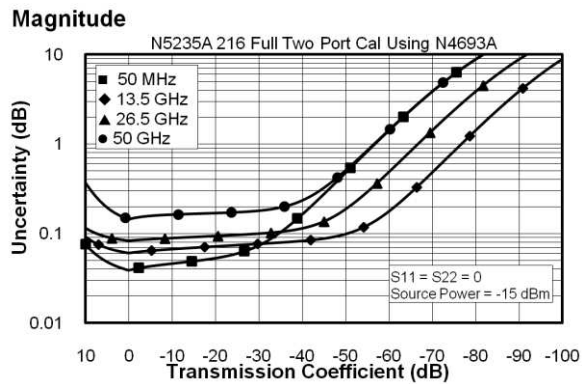
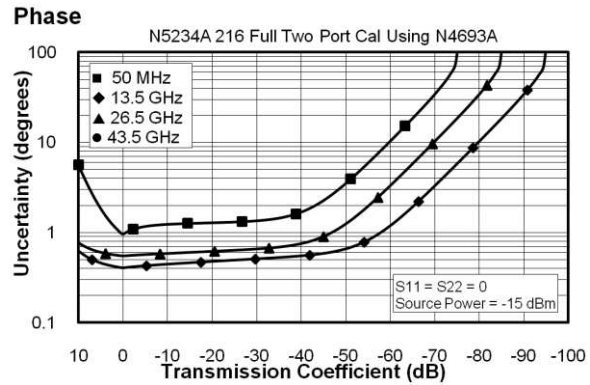
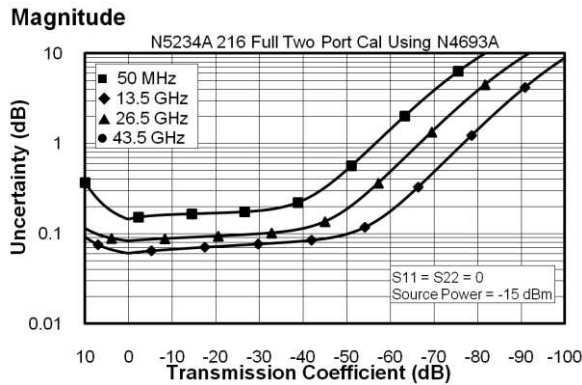

**Table 4. N4693A 2-Port Electronic Calibration Module**

Description	Specification (dB)						
	10 MHz to 50 MHz	50 MHz to 2 GHz	2 GHz to 10 GHz	10 GHz to 20 GHz	20 GHz to 30 GHz	30 GHz to 40 GHz	40 GHz to 50 GHz
Directivity	-55	-55	-49	-49	-45	-43	-41
Source Match	-46	-46	-42	-42	-37	-35	-30
Load Match	-45	-45	-41	-40	-36	-34	-29
Reflection Tracking <sup>1</sup>							
Mag	0.030	0.030	0.040	0.040	0.050	0.060	0.080
Phase (°/°C)	0.198	0.198	0.264	0.264	0.330	0.396	0.528
Transmission Tracking <sup>1</sup>							
Mag	0.032	0.032	0.049	0.051	0.069	0.084	0.123
Phase (°/°C)	0.211	0.211	0.321	0.336	0.457	0.556	0.812

<sup>1</sup>Temperature deviation is a characteristic value.

**Transmission Uncertainty, All Options**



## Reflection Uncertainty, All Options

### Magnitude

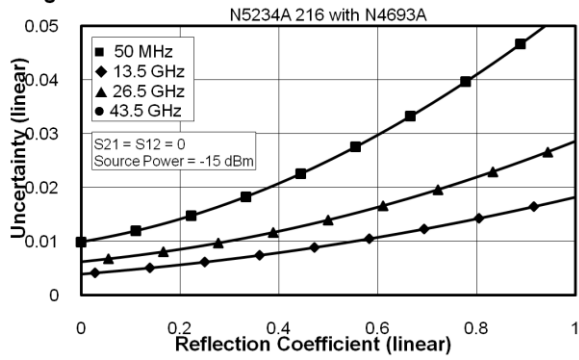

### Phase

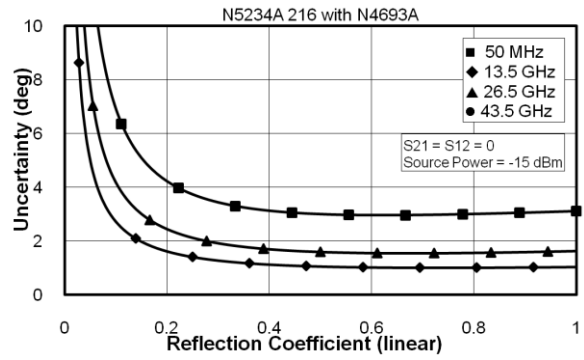

### Magnitude

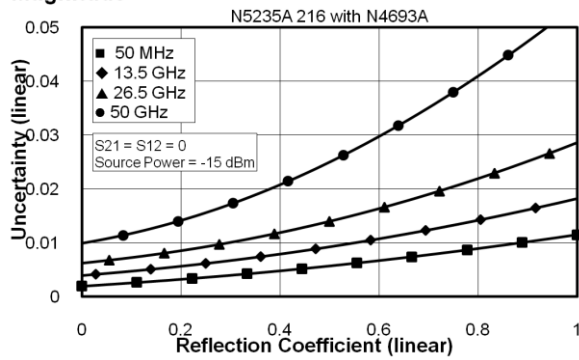

### Phase

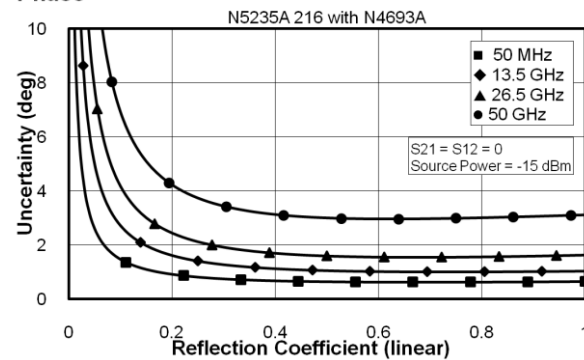

## Uncorrected System Performance

Specifications apply to following conditions:

- Over environmental temperature of 25 °C  $\pm$ 5 °C, with less than 1°C variation from the calibration temperature.
- Cable loss not included in Transmission Tracking.
- Crosstalk measurement conditions: normalized to a thru, measured with shorts on all ports, 10 Hz IF bandwidth, averaging factor of 8, alternate mode, source power set to the specified maximum power.

**Table 5a. Error Terms (dB), All Models, All Ports, All Options - Specifications**

Description	Directivity	Source Match	Load Match	Transmission Tracking	Reflection Tracking	Crosstalk
10 MHz to 45 MHz	-15	-9	-10	--	--	--
45 MHz to 2 GHz	-23	-17	-18	--	--	--
2 GHz to 8.5 GHz	-21	-12	-13	--	--	--
8.5 GHz to 12.5 GHz	-16	-11	-11	--	--	--
12.5 GHz to 20 GHz	-16	-11	-9	--	--	--
20 GHz to 40 GHz	-15	-7	-8	--	--	--
40 GHz to 50 GHz	-13	-5	-5	--	--	--

**Table 5b. Error Terms (dB), All Models, All Ports, All Options - Typical**

Description	Directivity	Source Match	Load Match	Transmission Tracking	Reflection Tracking	Crosstalk
10 MHz to 45 MHz	-21	-13	-14	+/- 2.5	+/- 1.5	-86
45 MHz to 200 MHz	-27	-25	-26	+/- 2.5	+/- 1.5	-94
200 MHz to 500 MHz	-30	-25	-22	+/- 2.5	+/- 1.5	-94
500 MHz to 2GHz	-30	-25	-22	+/- 2.5	+/- 1.5	-95
2 GHz to 8.5 GHz	-25	-20	-17	+/- 2.5	+/- 1.5	-105
8.5 GHz to 12.5 GHz	-22	-16	-15	+/- 3.0	+/- 1.5	-110
12.5 GHz to 13.51GHz	-19	-16	-14	+/- 3.0	+/- 1.5	-110
13.51 GHz to 20 GHz	-19	-16	-14	+/- 3.0	+/- 1.5	-108
20 GHz to 26.5 GHz	-20	-14	-13	+/- 5.0	+/- 2.0	-97
26.5 GHz to 40 GHz	-19	-14	-13	+/- 5.0	+/- 2.0	-97
40 GHz to 43.5 GHz	-19	-10	-10	+/- 5.0	+/- 2.5	-89
43.5 GHz to 50 GHz	-18	-10	-10	+/- 5.0	+/- 2.5	-89

## Test Port Output

**Table 6. Frequency Information, All Options**

Description	Specification		Typical	
	Option 200	Option 216	Option 200	Option 216
N5234A Frequency Range	10 MHz to 43.5 GHz		--	
N5235A Frequency Range	10 MHz to 50 GHz		--	
Frequency Resolution	1 Hz		--	
Frequency Accuracy	+/- 1 ppm		--	
Frequency Stability	--		+/-0.05 ppm, -10° to 70° C <sup>1</sup> +/-0.1 ppm/yr maximum <sup>2</sup>	

<sup>1</sup> Assumes no variation in time.

<sup>2</sup> Assumes no variation in temperature.

**Table 7a. Maximum Levelled Power (dBm), N5234A , All Ports<sup>1</sup>**

Description	Specification		Typical	
	Option 200	Option 216	Option 200	Option 216
10 MHz to 45 MHz	0	0	4	4
45 MHz to 500 MHz	0	0	7	7
500 MHz to 2 GHz	0	0	9	9
2 GHz to 12.5 GHz	0	0	10	9
12.5 GHz to 20 GHz	0	0	9	7
20 GHz to 40 GHz	-5	-8	5	2
40 GHz to 43.5 GHz	-10	-10	0	-4

<sup>1</sup> Any port can be used as the source port.

**Table 7b. Maximum Levelled Power (dBm), N5235A, All Ports<sup>1</sup>**

Description	Specification		Typical	
	Option 200	Option 216	Option 200	Option 216
10 MHz to 45 MHz	0	0	4	4
45 MHz to 500 MHz	0	0	7	7
500 MHz to 2 GHz	0	0	9	9
2 GHz to 12.5 GHz	0	0	10	9
12.5 GHz to 20 GHz	0	0	9	7
20 GHz to 40 GHz	-5	-8	5	2
40 GHz to 50 GHz	-11	-15	0	-4

<sup>1</sup> Any port can be used as the source port.

**Table 8. Power Level Accuracy (dB) at Nominal Power<sup>1</sup>, All Models, All Options, All Ports<sup>2</sup>**

Description	Specification		Typical	
	Option 200	Option 216	Option 200	Option 216
10 MHz to 45 MHz	+/-1.5		+/-0.18	
45 MHz to 500 MHz	+/-1.5		+/-0.13	
500 MHz to 10.5 GHz	+/-1.5		+/-0.07	
10.5 GHz to 20 GHz	+/-1.5		+/-0.08	
20 GHz to 40GHz	+/-1.5		+/-0.11	
40 GHz to 43.5 GHz	+/-2.5		+/-0.14	
43.5 GHz to 50 GHz	+/-3.0		+/-0.23	

<sup>1</sup> Level accuracy at power other than nominal power, Power Level Accuracy (dB) at Nominal Power + Power Level Linearity (dB)

<sup>2</sup> Either port can be used as the source port.

**Table 9. Power Level Linearity<sup>1</sup> (dB), All Models, All Options, All Ports<sup>2</sup> - Specification**

Description	Specification		
	-25 dBm ≤ P < -20 dBm	-20 dBm ≤ P < -15 dBm	P ≥ -15 dBm
10 MHz to 45 MHz	+/-2.0	+/-1.5	+/-1.5
45 MHz to 50 GHz	+/-1.5	+/-1.5	+/-1.5

<sup>1</sup> Referenced to nominal power.

<sup>2</sup> Either port can be used as the source port.

**Table 10. Power Sweep Range (dB), All Models, All Ports<sup>1</sup>**

Description	Specification		Typical	
	Option 200	Option 216	Option 200	Option 216
	10 MHz to 45 MHz	25	25	31
45 MHz to 500 MHz	25	25	34	34
500 MHz to 2 GHz	25	25	36	36
2 GHz to 12.5 GHz	25	25	37	36
12.5 GHz to 20 GHz	25	25	36	34
20 GHz to 40 GHz	20	17	32	29
40 GHz to 50 GHz	14	10	27	23

<sup>1</sup> Either port can be used as the source port.

**Table 11. Nominal Power (Preset,dBm), All Ports<sup>1</sup>, All Options**

Description	N5234A	N5235A
Preset Power	-10	-15

<sup>1</sup> Either port can be used as the source port.

**Table 12. Power Resolution and Maximum/Minimum Settable Power, All Models, All Ports<sup>1</sup>**

Description	Specification (dB)	Typical (dBm)		
	All Options	All Options	Option 200	Option 216
Power Resolution	0.01	--	--	--
Maximum Settable Power	--	30	--	--
Minimum Settable Power	--	--	-30	-90

<sup>1</sup> Either port can be used as the source port.

**Table 13. 2<sup>nd</sup> and 3<sup>rd</sup> Harmonics at Max Specified Power (dBc) All Options, All Ports<sup>1</sup> - Typical**

Description <sup>2</sup>	N5234A	N5235A
20 MHz to 500 MHz	-22	-22
500 MHz to 2 GHz	-25	-25
2 GHz to 15 GHz	-30	-30
15 GHz to 20 GHz	-35	-35
20 GHz to 40 GHz	-33	-33
40 GHz to 43.5 GHz	-29	-29
43.5 GHz to 50 GHz	--	-29

<sup>1</sup> Either port can be used as the source port.

<sup>2</sup> Listed frequency is harmonic frequency; test at max specified power

**Table 14. Non-Harmonic Spurs at Nominal Power (dBc), All Models,All Options - Typical**

Description	Based on 8 kHz offset Frac-N	Based on 100 kHz offset Frac-N
10 MHz to 500 MHz	-50	-50
500 MHz to 2 GHz	-60	-42
2 GHz to 4 GHz	-57	-45
4 GHz to 8 GHz	-51	-39
8 GHz to 16 GHz	-45	-33
16 GHz to 32 GHz	-39	-27
32 GHz to 50 GHz	-33	-21

**Table 15. Phase Noise (dBc/Hz), All Models, All Options - Typical**

<b>Description</b>	<b>1 kHz Offset</b>	<b>10 kHz Offset</b>	<b>100 kHz Offset</b>	<b>1 MHz Offset</b>
10 MHz to 50 MHz	-95	-101	-101	-117
50 MHz to 1 GHz	-96	-101	-101	-119
1 GHz to 2 GHz	-91	-105	-102	-121
2 GHz to 4 GHz	-85	-99	-96	-115
4 GHz to 8 GHz	-79	-93	-90	-109
8 GHz to 16 GHz	-73	-87	-84	-103
16 GHz to 32 GHz	-67	-81	-78	-97
32 GHz to 50 GHz	-61	-75	-72	-91

## Test Port Input

**Table 16. Noise Floor<sup>1</sup> (dBm) @ 10 Hz IFBW, All Models, All Ports**

Total average (rms) noise power calculated as the mean value of a linear magnitude trace expressed in dBm.

May typically be degraded at particular frequencies below 500 MHz due to spurious receiver residuals.

Description	Specification		Typical	
	Options 200, 216	Option 216	Options 200, 216	Option 216
	Test Port	Direct Receiver Access Port	Test Port	Direct Receiver Access Port
10 MHz to 45 MHz <sup>2</sup>	-75	-110	-90	134
45 MHz to 500 MHz <sup>2</sup>	-90	-102	-110	125
500 MHz to 2 GHz	-110	-122	-120	135
2 GHz to 8.5 GHz	-110	-122	-121	136
8.5 GHz to 12.5 GHz	-110	-122	-122	137
12.5 GHz to 13.5 GHz	-110	-122	-122	137
13.5 GHz to 20 GHz	-100	-112	-111	126
20 GHz to 40 GHz	-100	-110	-111	124
40 GHz to 50 GHz	-90	-98	-104	115

<sup>1</sup>Total average (rms) noise power calculated as the mean value of a linear magnitude trace expressed in dBm.

<sup>2</sup>May typically be degraded at particular frequencies below 500 MHz due to spurious receiver residuals.

**Table 17. 0.1 dB Receiver Compression at Test Port (dBm), All Models, All Options, All Ports - Typical**

Description	Typical
10 MHz to 500 MHz	10
500 MHz to 13.51 GHz	7
13.51 GHz to 20 GHz	6
20 GHz to 35 GHz	5
35 GHz to 40 GHz	3
40 GHz to 43.5 GHz	1
43.5 GHz to 47 GHz	0
47 GHz to 50 GHz	-1

**Table 18. Receiver Compression at Test Port Power, All Models, All Options, All Ports - Specification**

Description	Test Port Power (dBm)	Magnitude (dB)		Phase (degrees)	
10 MHz to 50 MHz <sup>1</sup>	-	-	-	-	-
50 MHz to 30 GHz	5	0.40		3.5	
30 GHz to 35 GHz	5	0.40		5.0	
35 GHz to 40 GHz	5	0.60		5.0	
40 GHz to 43.5 GHz	5	0.65		5.0	
43.5 GHz to 47 GHz	1	0.55		5.0	
47 GHz to 50 GHz	-5	0.25		5.0	

<sup>1</sup> Test port receiver compression at specified input levels below 50 MHz is negligible due to coupler roll off in this frequency range.

**Table 19a. Trace Noise<sup>1</sup> Magnitude (dB rms), All Models, All Options**

Description	Specification	Typical		
		1 kHz IFBW	100 kHz IFBW	600 kHz IFBW
10 MHz to 45 MHz	0.200	0.071	0.700	2.000
45 MHz to 100 MHz	0.020	0.009	0.130	0.400
10 MHz to 500 MHz	0.020	0.004	0.130	0.200
500 MHz to 13.51 GHz	0.006	0.001	0.035	0.090
13.51 GHz to 40 GHz	0.010	0.003	0.075	0.200
40 GHz to 50 GHz	0.020	0.004	0.100	0.300

<sup>1</sup> Ratioed measurement, nominal power at test port.

**Table 19b. Trace Noise<sup>1</sup> Phase (deg rms), All Models, All Options**

Description	Specification	Typical		
		1 kHz IFBW	100 kHz IFBW	600 kHz IFBW
10 MHz to 45 MHz	1.000	0.490	4.700	12.000
45 MHz to 100 MHz	0.100	0.029	1.500	3.000
100 MHz to 500 MHz	0.100	0.010	0.500	1.500
500 MHz to 13.5 GHz	0.060	0.008	0.500	0.700
13.5 GHz to 40 GHz	0.100	0.021	0.700	1.300
40 GHz to 50 GHz	0.200	0.030	1.000	2.000

<sup>1</sup> Ratioed measurement, nominal power at test port.

**Table 20. Reference Level Magnitude, All Models and Options - Specification**

Description	Magnitude (dB)	Phase (degrees)
Range	+/- 500	+/- 500
Resolution	0.001	0.01

**Table 21. Stability<sup>1</sup>, All Models, All Options - Typical**

Description	Magnitude (dB/°C)	Phase (°/°C)
10 MHz to 45 MHz	0.02	0.25
45 MHz to 500 MHz	0.01	0.05
500 MHz to 2 GHz	0.01	0.03
2 GHz to 4 GHz	0.01	0.05
4 GHz to 8 GHz	0.01	0.09
8 GHz to 13.5 GHz	0.01	0.15
13.5 GHz to 20 GHz	0.01	0.20
20 GHz to 40 GHz	0.03	0.45
40 GHz to 50 GHz	0.03	0.55

<sup>1</sup> Stability is defined as a ratio measurement made at the test port.

**Table 22a. Damage Level, All Models, Option 200 - Typical**

Description	RF (dBm)	DC (VDC)
Ports 1, 2	30	40

**Table 22b. Damage Level, All Models, Option 216 - Typical**

Description	RF (dBm)	DC (VDC)
Ports 1, 2	30	7
RCVR A, B IN	15	7
REF RCVR R1, R2 IN	15	7
REF 1, 2 SOURCE OUT	20	7
PORT 1, 2 SOURCE OUT	30	7
PORT 1, 2 CPLR THRU	30	7
PORT 1, 2 CPLR ARM	30	7

## Dynamic Accuracy

Dynamic accuracy is verified with the following measurements:

- Compression over frequency
- IF linearity at a single frequency of 1.998765GHz using a reference level of -20 dBm for an input power range of 0 to -60 dBm. For values below -60 dBm, refer to "[VNA Receiver Dynamic Accuracy Specifications and Uncertainties](#)"

**Table 23. Dynamic Accuracy - Specification**

### Dynamic Accuracy, 50 MHz

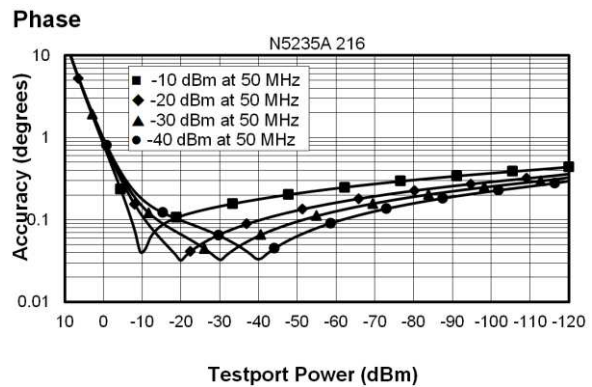
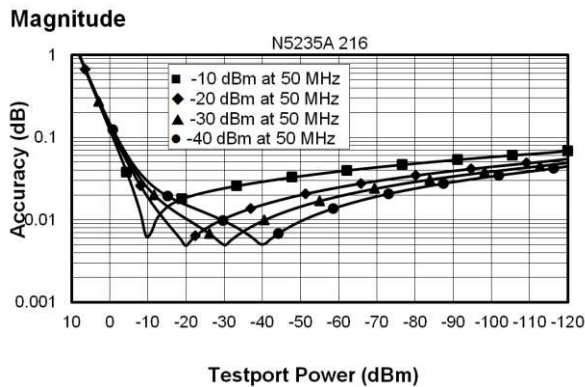

### Dynamic Accuracy, 500 MHz

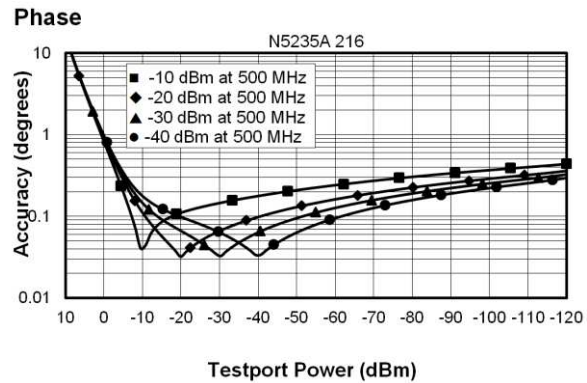
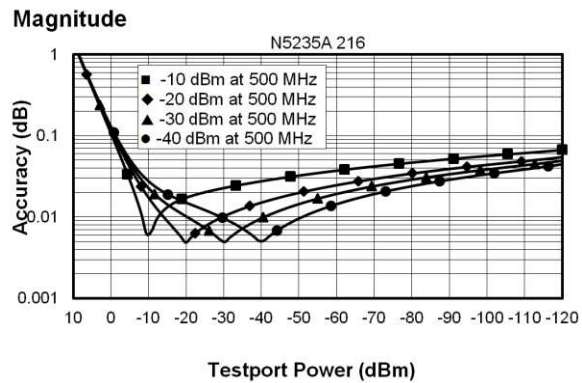

## Dynamic Accuracy, 1 GHz

Magnitude

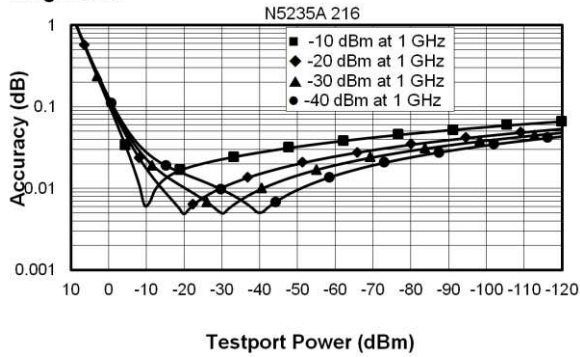

Phase

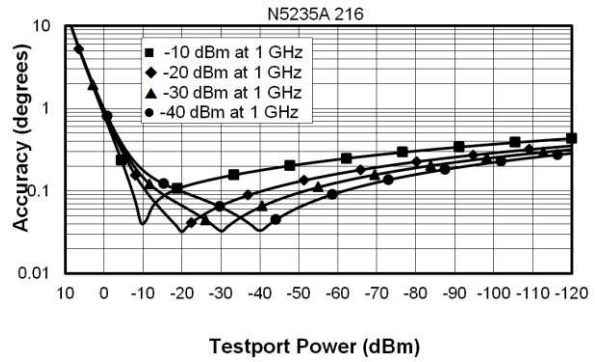

## Dynamic Accuracy, 2 GHz

Magnitude

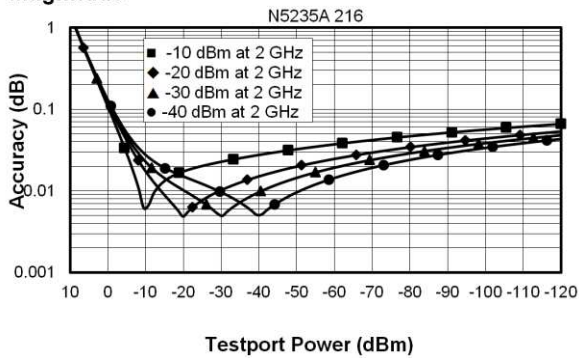

Phase

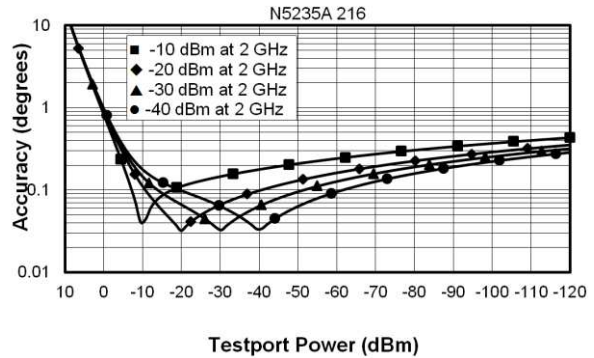

## Dynamic Accuracy, 20 GHz

Magnitude

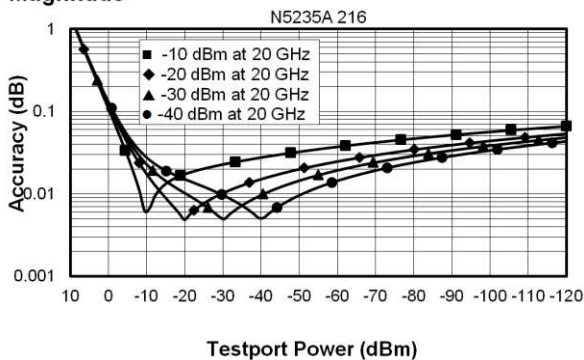

Phase

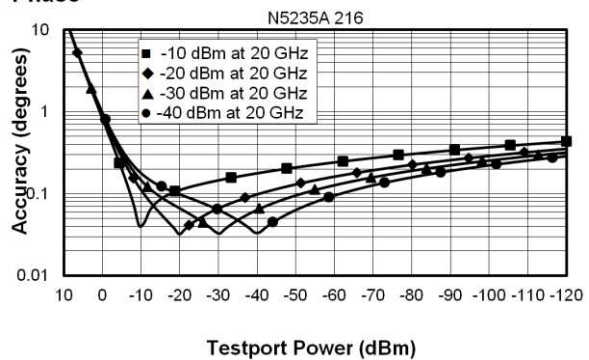

## Dynamic Accuracy, 35 GHz

Magnitude

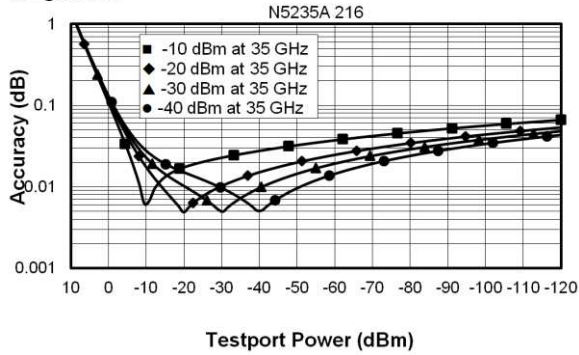

Phase

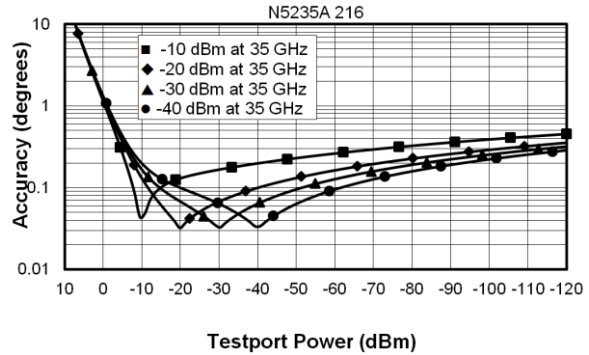

## Dynamic Accuracy, 40 GHz

Magnitude

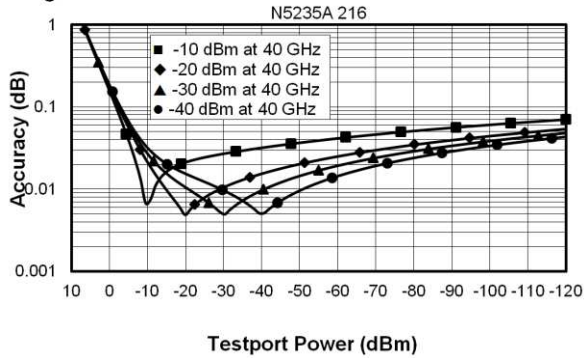

Phase

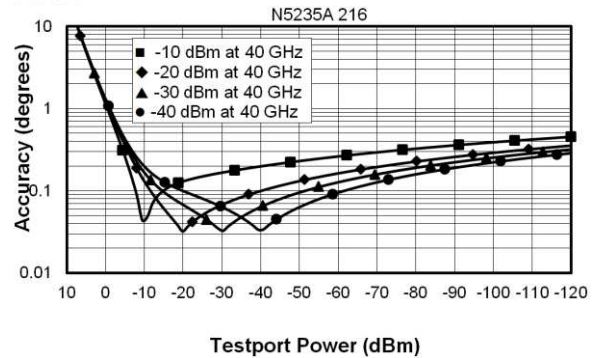

## Dynamic Accuracy, 50 GHz

Magnitude

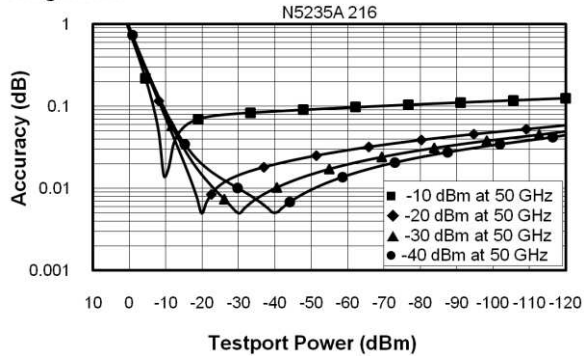

Phase

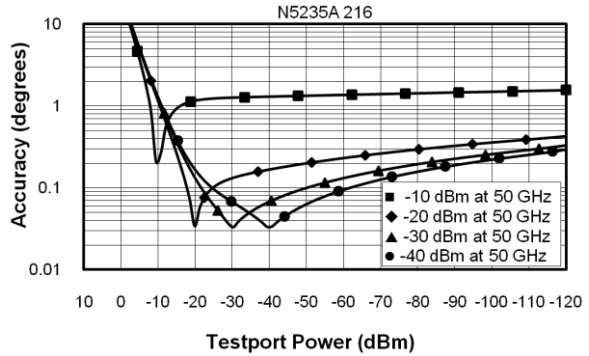

**Table 24. Group Delay<sup>1</sup>**

In general, the following formula can be used to determine the accuracy, in seconds, of specific group delay measurement:

$$\pm \text{Phase Accuracy (deg)} / [360 \times \text{Aperture (Hz)}]$$

Depending on the aperture and device length, the phase accuracy used is either incremental phase accuracy or worst-case phase accuracy

Description	Typical Performance
Aperture (selectable)	(frequency span)/(number of points -1)
Maximum Aperture	20% of frequency span
Range	0.5 x (1/minimum aperture)
Maximum Delay	Limited to measuring no more than 180° of phase change within the minimum aperture.)

The following graphs show characteristic group delay accuracy with full 2-port calibration and a 10 Hz IF bandwidth. Insertion loss is assumed to be < 2 dB and electrical length to be ten meters.

For any  $S_{ij}$  Group Delay measurement,  $S_{ii} = 0$ ,  $S_{ij} = 1$ ,  $S_{ji} = 0$ ,  $S_{kl} = 0$  for all  $kl \neq ij$

### Group Delay (Typical)

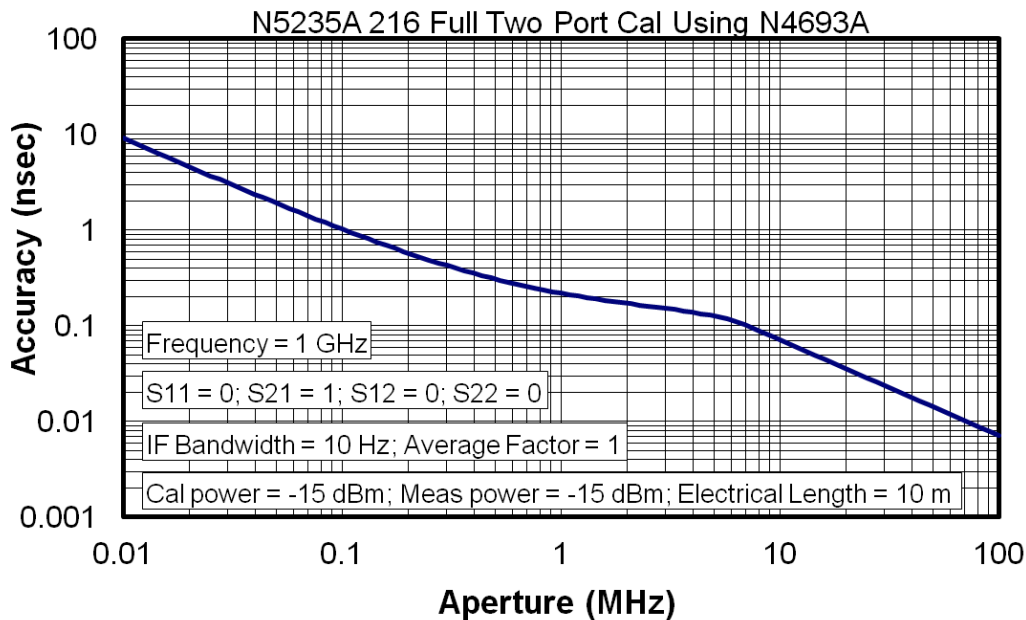

In general, the following formula can be used to determine the accuracy, in seconds, of specific group delay measurement:

$$\pm \text{Phase Accuracy (deg)} / [360 \times \text{Aperture (Hz)}]$$

Depending on the aperture and device length, the phase accuracy used is either incremental phase accuracy or worst-case phase accuracy

<sup>1</sup> Group delay is computed by measuring the phase change within a specified frequency step (determined by the frequency span and the number of points per sweep).

## General Information

- [Miscellaneous Information](#)
- [Front Panel](#)
- [Rear Panel](#)
- [Environment and Dimensions](#)

**Table 25. Miscellaneous Information**

Description	Supplemental Information
System IF Bandwidth Range	1 Hz to 15 MHz, nominal
CPU	Intel® 1.87 GHz Celeron® with 4 GByte RAM
LXI	Class C

**Table 26. Front Panel Information, All Options**

Description	Typical Performance
<b>RF Connectors</b>	
Test Ports	2.4 mm (male), 50 ohm, (nominal), 0.002 in. (characteristic)
Jumpers (Option 216)	2.4 mm (female) connectors with 2.4 mm (male) jumper cables
<b>USB 2.0 Ports - Master (4 ports)</b>	
Standard	Compatible with USB 2.0
Connector	USB Type-A female
<b>Display</b>	
Size	26.3 cm (10.4 in) diagonal color active matrix LCD; 1024 (horizontal) X 768 (vertical) resolution
Refresh Rate	Vertical 60 Hz; Horizontal 46.08 kHz
Pixels	Any of the following would cause a display to be considered faulty: <ul style="list-style-type: none"><li>• A complete row or column consists of “stuck” or “dark” pixels.</li><li>• More than six “stuck on” pixels (but not more than three green) or more than 0.002% of the total pixels are within the LCD specifications.</li><li>• More than twelve “dark” pixels (but no more than seven of the same color) or more than 0.004% of the total pixels are within the LCD specifications.</li><li>• Two or more consecutive “stuck on” pixels or three or more consecutive “dark” pixel (but no more than one set of two consecutive dark pixels)</li><li>• “Stuck on” “dark” pixels are less than 6.5 mm apart (excluding consecutive pixels)</li></ul>

**Table 26 (Continued) Front Panel Information, All Options**

Description	Typical Performance
<b>Display Range</b>	
Magnitude	+/-2500 dB (at 500 dB/div), max
Phase	+/-2500° (at 500 dB/div), max
Polar	10 pUnits, min 10,000 Units, max
<b>Display Resolution</b>	
Magnitude	0.001 dB/div, min
Phase	0.01°/div, min
<b>Marker Resolution</b>	
Magnitude	0.001 dB, min
Phase	0.01°, min
Polar	10 pUnit, min

**Table 27. Rear Panel Information, All Options**

Description	Typical Performance
<b>10 MHz Reference In</b>	
Connector	BNC, female
Input Frequency	10 MHz ± 10 ppm
Input Level	-15 dBm to +20 dBm
Input Impedance	200 Ω, nom.
<b>10 MHz Reference Out</b>	
Connector	BNC, female
Output Frequency	10 MHz ± 1 ppm
Signal Type	Sine Wave
Output Level	+10 dBm ± 4 dB into 50 Ω
Output Impedance	50 Ω, nominal
Harmonics	<-40 dBc, typical

**Table 27. (Continued) Rear Panel Information, All Options**

<b>Description</b>	<b>Typical Performance</b>
<b>VGA Video Output</b>	
Connector	15-pin mini D-Sub; Drives VGA compatible monitors
<b>Devices Supported</b>	<b>Resolutions</b>
Flat Panel (TFT)	1024 X 768, 800 X 600, 640 X 480
Flat Panel (DSTN)	800 X 600, 640 X 480
CRT Monitor	1280 X 1024, 1024 X 768, 800 X 600, 640 X 480
Simultaneous operation of the internal and external displays is allowed, but with 640 X 480 resolution only. If you change resolution, you can only view the external display (internal display will "white out").	
Trigger Inputs/Outputs	BNC(f), TTL/CMOS compatible
Test Set IO	25-pin D-Sub connector, available for external test set control.
Power IO	9-pin D-Sub, female; analog and digital IO
Handler IO	36-pin parallel I/O port; all input/output signals are default set to negative logic; can be reset to positive logic via GPIB command.
GPIB	Two ports - dedicated controller and dedicated talker/listener. 24-pin D-sub (Type D-24), female; compatible with IEEE-488.
Parallel Port (LPT1)	25-pin D-Sub miniature connector, female; provides connection to printers or any other parallel port peripherals
USB Ports	Four ports on front panel (all Host) and five ports (four Host and one Device) on rear panel. Type A configuration (eight Host) and Type B configuration (one Device), USB 2.0 compatible. The total current limit for all rear panel USB ports is 2.0 amps. The total current limit for all front panel USB is 0.9 amps.
LAN	10/100BaseT Ethernet, 8-pin configuration; auto selects between the two data rates
<b>Line Power</b>	
Frequency, Voltage	50/60/ Hz for 100 to 120 VAC 50/60 Hz for 220 to 240 VAC
	Power supply is auto switching
Max	350 watts

## Table 28. Analyzer Dimensions and Weight

All models are shipped with bottom feet, handles and front and rear hardware.

See detailed PNA dimension drawings at: <http://na.tm.agilent.com/pna/PNADimensions.pdf>

<b>Cabinet Dimensions</b>	<b>Metric (mm)</b>	<b>Imperial (inches)</b>
<b>Height</b>		
Without bottom feet: EIA RU <sup>1</sup> = 6	266.1	10.5
With bottom feet	279.1	11
<b>Width</b>		
Without handles or rack-mount flanges	425.6	16.8
With handles, without rack-mount flanges	458.7	18.1
With handles and rack-mount flanges	482.9	19.0
<b>Depth</b>		
Without front and rear panel hardware	445.7	17.5
With front and rear panel hardware, handles	497.2	19.6
<b>Weight (nominal)</b>		
	<b>Net</b>	<b>Shipping</b>
2-port model (Option 216)	24.6 kg (52 lb)	34.9 kg (77 lb)

<sup>1</sup>Electronics Industry Association rack units. 1 RU = 1.75 in.

## Regulatory and Environmental Information

For Regulatory and Environmental information, refer to the PNA-L Series Installation and Quick Start Guide, located online at <http://cp.literature.agilent.com/litweb/pdf/E8356-90001.pdf>.

## Measurement Throughput Summary

- [Typical Cycle Time for Measurement Completion](#)
- [Cycle Time vs. IF Bandwidth](#)
- [Cycle Time vs. Number of Points](#)
- [Data Transfer Time](#)

Cycle time Includes sweep time, retrace time and band-crossing time. Analyzer display turned off with DISPLAY:ENABLE OFF. Add 21 ms for display on. Data for one trace (S<sub>11</sub>) measurement.

**Table 29. Cycle Time (ms) for Measurement Completion, All Options - Typical**

Sweep Range	IF Bandwidth		Number of Points				
			201	401	1601	16001	32001
<b>9 GHz to 10 GHz, All Models</b>	600 kHz	Uncorrected	6	6	9	55	106
		2-Port cal	10	11	19	115	216
	10 kHz	Uncorrected	29.1	54	203	1992	3978
		2-Port cal	59	109	408	3595	6397
	1 kHz	Uncorrected	227	453	1743	17011	33792
		2-Port cal	460	904	3423	27238	45100
<b>10 MHz to 43.5 GHz, N5234A</b>	600 kHz	Uncorrected	47	51	61	149	194
		2-Port cal	93	101	121	300	392
	10 kHz	Uncorrected	80	142	497	2037	4042
		2-Port cal	161	285	995	4078	8094
	1 kHz	Uncorrected	246	472	1813	17592	34938
		2-Port cal	497	950	3633	35194	46620
<b>10 MHz to 50 GHz, N5235A</b>	600 kHz	Uncorrected	48	54	63	151	197
		2-Port cal	99	108	127	304	399
	10 kHz	Uncorrected	80	142	500	2034	4040
		2-Port cal	161	285	998	4080	8089
	1 kHz	Uncorrected	246	472	1814	17612	34979
		2-Port cal	497	950	3277	28203	55994

**Table 30. Cycle Time vs. IF Bandwidth - Typical**

Applies to the Preset condition (201 points, correction off) except for the following changes:

- CF = 10 GHz
- Span = 100 MHz
- Display off (add 21 ms for display on)

Cycle time includes sweep and retrace time.

<b>Description</b>		<b>N5234A/35A</b>	
<b>IF Bandwidth (Hz)</b>	<b>Cycle Time (ms)</b>	<b>Trace Noise Magnitude (dB rms)</b>	
600,000	6	0.0035	
100,000	7	0.0016	
30,000	9	0.0010	
10,000	29	0.0005	
3,000	71	0.0004	
1,000	222	0.0001	
300	640	0.0001	
100	1823	0.00006	
30	5980	0.00006	
10	17828	0.00006	
3	59273	0.00006	

**Table 31. Cycle Time vs. Number of Points - Typical**

Applies to the Preset condition (correction off) except for the following changes:

- CF = 10 GHz
- Span = 100 MHz
- Display off (add 21 ms for display on)

Cycle time includes sweep and retrace time.

Description	IF Bandwidth (Hz)			
	1,000	10,000	30,000	600,000
3	7	6	6	6
11	16	6	6	6
51	60	10.4	6	6
101	114	17	7	6
201	222	29	9	6
401	436	54	14	6
801	861	104	24	7
1,601	1706	203	44	9
6,401	6718	799	164	25
16,001	16641	1991	403	55
32,001	33057	3974	803	106

**Table 32. Data Transfer Times - Typical**

- Values are for Real & Imaginary pairs (two values per point)
- Results measured with the analyzer display off. Values will increase slightly if the analyzer display is on.
- LAN values assume a gigabit connection and are highly dependent upon both LAN conditions and the computer used
- All values are approximate. Example values shown are actual averaged measured results and include the time required to send the command to request the data

Description	General Formula	Example for 1601 Points	Example for 32001 Points
<b>SCPI over GPIB<sup>1</sup></b> (Program executed on external PC)			
32-bit floating point	1mS + .024 mS/point	39 mS	755 mS
ASCII	1mS + 0.185mS/point	300 mS	5850 mS
<b>SICL over LAN</b> (Program executed on external PC)			
32-bit floating point	0.5 mS + 0.18 μS/point	0.78 mS	6.4 mS
ASCII	0.5 mS + .012 mS/point	20.4 mS	390 mS
<b>SICL</b> (Program executed within the analyzer)			
32-bit floating point	0.3 mS + 0.18 μS/point	0.64 mS	6.2 mS
ASCII	0.3 mS + .012 mS/point	20.2 mS	388 mS
<b>COM</b> (Program executed within the analyzer)			
32-bit floating point	130 μS + .012 μS/point	0.14 mS	0.5 mS
Variant type	130 μS + 1.7 μS/point	2.7 mS	56 mS
<b>DCOM over LAN</b> (Program executed on external PC)			
32-bit floating point	350 μS + 0.17 μS/point	0.55 mS	5.7 mS
Variant type	350 μS + 3.4 μS/point	5.8 mS	108 mS

<sup>1</sup> Values obtained using USB-to-GPIB adapter (82357B)

**Note:** Internally, the PNA measurement data is handled in 32-bit (single-precision) format. Therefore, there is no need to use 64-bit transfers for most data. Frequency values however, may be rounded slightly with 32-bit transfers since there is insufficient resolution in this format to represent higher frequencies with 1 Hz accuracy. If this type of accuracy is needed for frequencies, then you should use 64-bit transfers. Specifications for Recall & Sweep Speed are not provided for the N532xA analyzers.

## Specifications: Front-Panel Jumpers

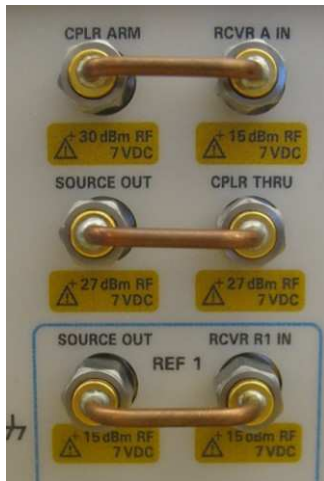

The following options have front-panel jumpers for each port:

Option 216

- [Measurement Receiver Inputs](#)
- [Reference Receiver Inputs and Reference Source Outputs](#)
- [Source Outputs](#)
- [Coupler Inputs](#)

**Table 33. Measurement Receiver Inputs (dBm), Option 216 - Typical**

(RCVR A,, B IN) @ 0.1dB Typical Compression

Description	Option 216
10 MHz to 45 MHz	-34
45 MHz to 500 MHz	-20
500 MHz to 35 GHz	-9
35 GHz to 43.5 GHz	-11
43.5 GHz to 47GHz	-12
47 GHz to 50 GHz	-13

**Table 34. Reference Receiver Inputs and Reference Source Outputs (dBm) - Typical**

(RCVR R1, R2 IN, REF 1, 2 SOURCE OUT) @ Specified Maximum Levelled Power

Description	Option 216
10 MHz to 8.5 GHz	-28
8.5 GHz to 20 GHz	-26
20 GHz to 35 GHz	-30
35 GHz to 40 GHz	-27
40 GHz to 43.5 GHz	-29
43.5 GHz to 50 GHz	-28

**Table 35. Source Outputs (dBm) - Typical****(PORT 1, 2 SOURCE OUT) @ Specified Maximum Levelled Power**

<b>Description</b>	<b>Option 216</b>
10 MHz to 12.5 GHz	1
12.5 GHz to 20 GHz	3
20 GHz to 40 GHz	-4
40 GHz to 50 GHz	-11

**Table 36. Coupler Inputs (dB) - Typical****(PORT 1, 2 CPLR THRU) Insertion Loss of Coupler Thru**

<b>Description</b>	<b>Option 216</b>
10 MHz to 500 MHz	0.6
500 MHz to 2 GHz	0.8
2 GHz to 20 GHz	2.0
20 GHz to 40 GHz	2.5
40 GHz to 50 GHz	3.0

## Test Set Block Diagrams

NOTE: For best readability, use a color printer for printing the following graphics.

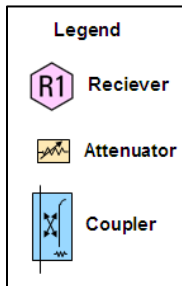

### N5234A and N5235A Option 200 (2-port base model)

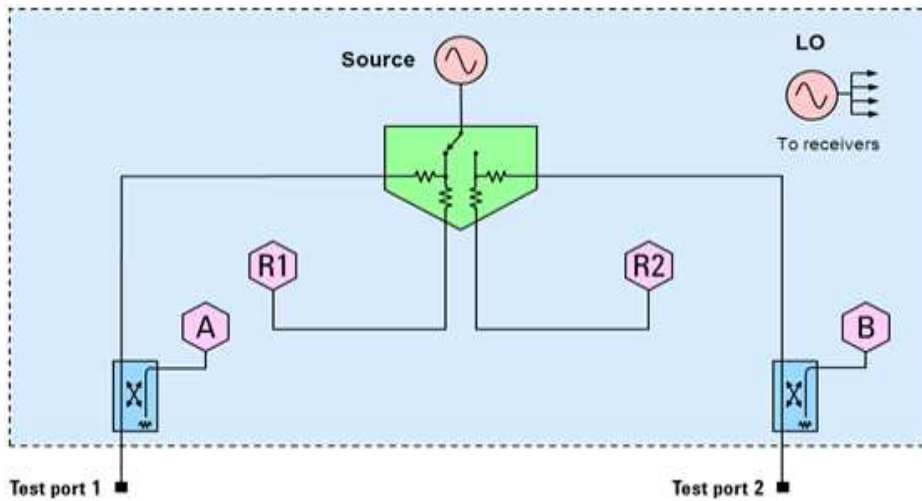

### N5234A and N5235A Option 216

To base model, adds front-panel jumpers and source attenuators

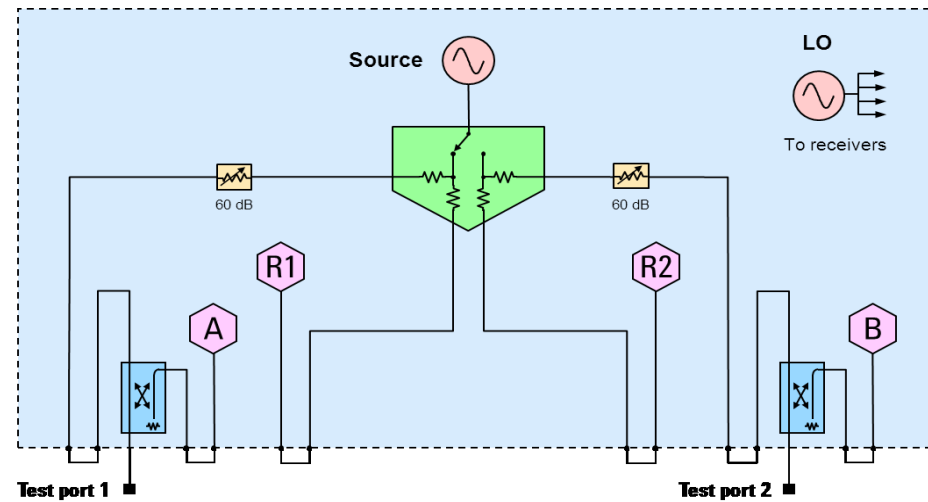

**Receiver Block Diagram**

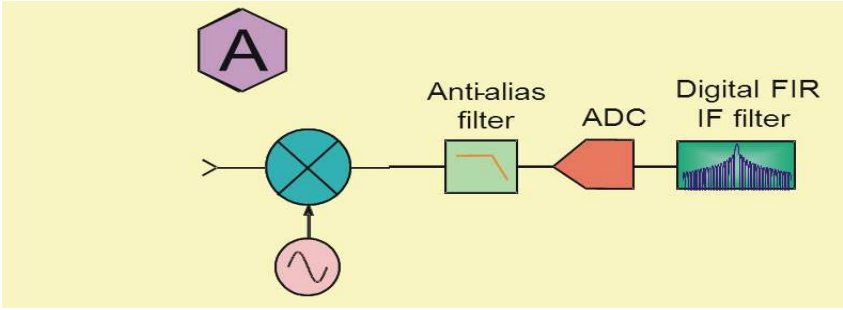



## Agilent Email Updates

### [www.agilent.com/find/emailupdates](http://www.agilent.com/find/emailupdates)

Get the latest information on the products and applications you select.



### [www.axiestandard.org](http://www.axiestandard.org)

AdvancedTCA® Extensions for Instrumentation and Test (AXIe) is an open standard that extends the AdvancedTCA for general purpose and semiconductor test. Agilent is a founding member of the AXIe consortium.



### [www.lxistandard.org](http://www.lxistandard.org)

LAN eXtensions for Instruments puts the power of Ethernet and the Web inside your test systems. Agilent is a founding member of the LXI consortium.



### [www.pxisa.org](http://www.pxisa.org)

PCI eXtensions for Instrumentation (PXI) modular instrumentation delivers a rugged, PC-based high-performance measurement and automation system.

## Agilent Channel Partners

### [www.agilent.com/find/channelpartners](http://www.agilent.com/find/channelpartners)

Get the best of both worlds: Agilent's measurement expertise and product breadth, combined with channel partner convenience.



Agilent Advantage Services is committed to your success throughout your equipment's lifetime. To keep you competitive, we continually invest in tools and processes that speed up calibration and repair and reduce your cost of ownership. You can also use Infoline Web Services to manage equipment and services more effectively. By sharing our measurement and service expertise, we help you create the products that change our world.

[www.agilent.com/find/advantageservices](http://www.agilent.com/find/advantageservices)



[www.agilent.com](http://www.agilent.com)

[www.agilent.com/find/PNA-L-Lx](http://www.agilent.com/find/PNA-L-Lx)

For more information on Agilent Technologies' products, applications or services, please contact your local Agilent office. The complete list is available at:

[www.agilent.com/find/contactus](http://www.agilent.com/find/contactus)

#### Americas

Canada	(877) 894-4414
Brazil	(11) 4197 3500
Mexico	01800 5064 800
United States	(800) 829-4444

#### Asia Pacific

Australia	1 800 629 485
China	800 810 0189
Hong Kong	800 938 693
India	1 800 112 929
Japan	0120 (421) 345
Korea	080 769 0800
Malaysia	1 800 888 848
Singapore	1 800 375 8100
Taiwan	0800 047 866
Other AP Countries	(65) 375 8100

#### Europe & Middle East

Belgium	32 (0) 2 404 93 40
Denmark	45 70 13 15 15
Finland	358 (0) 10 855 2100
France	0825 010 700* *0.125 €/minute
Germany	49 (0) 7031 464 6333
Ireland	1890 924 204
Israel	972-3-9288-504/544
Italy	39 02 92 60 8 484
Netherlands	31 (0) 20 547 2111
Spain	34 (91) 631 3300
Sweden	0200-88 22 55
United Kingdom	44 (0) 118 9276201

For other unlisted countries:

[www.agilent.com/find/contactus](http://www.agilent.com/find/contactus)

Product specifications and descriptions in this document subject to change without notice.

© Agilent Technologies, Inc.  
Published in USA, Dec. 7, 2012  
Supersedes: Aug. 31, 2012  
N5235-90003



Agilent Technologies