

# PT SERIES

## Pulse transformers designed for Semikron

### Features

- Voltage-time area ( $\int Vdt$ ) : from 250 $\mu$ Vs to 2000 $\mu$ Vs.
- Pulse rise time ( $t_r$ ): from 0,8 $\mu$ s to 4 $\mu$ s.
- Working voltage ( $V_w$ ): From 500Vac to 3200Vac.
- Isolation voltage according to IEC60664-1.
- Ambient temperature: -40°C to +85°C.
- Storage temperature: from -40°C to +120°C.
- Plastic case: UL 94V-0.
- Potting resin: UL94V-0.

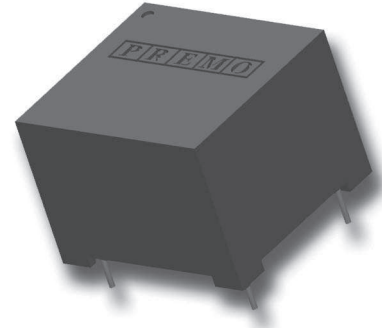

### Electrical specifications

Code	NP : Ns	$\int Vdt$ ( $\mu$ Vs)	$R_p$ TYP ( $\Omega$ )	$R_s$ TYP ( $\Omega$ )	$L_p$ (mH)	$L_{ss}$ MAX ( $\mu$ H)	$C_c$ (pF) TYP	$I_M$ (mA)	$t_r$ ( $\mu$ s)	$R_L$ ( $\Omega$ )	$V_w$ (V)	Visol P/S (kVac)	Visol S/S (kVac)	Config
PT 14b2,5	1:1:1	250	0,9	0,9	1,7	5	45	200	1	50	500	4	3	B
PT 14k2,5	1:1:1	250	0,9	0,9	1,7	5	45	200	1	50	500	4	3	C
PT 14c2,5	2:1	250	1,8	0,9	6,7	15	45	200	1	50	500	4	-	D
PT 14a3	1:1	350	1,2	1,2	2,9	20	40	300	1	50	500	4	-	A
PT 14i3	1:1	350	1,2	1,2	2,9	20	40	300	1	50	500	4	-	D
PT 14g3	2:1:1	300	4,0	2,5	11,4	20	50	300	1	50	500	4	3	B
PT 14c3,5	2:1	350	3,5	2,4	14	30	50	300	1	50	500	4	-	D
PT 14i5	1:1	500	2,5	2,5	5,6	15	45	350	1	50	500	4	-	D
PT 14k6	1:1:1	600	3,6	3,6	9,7	10	45	400	1,2	50	500	4	3	C
PT 22a3	1:1	300	0,6	0,6	3	4,5	40	800	0,8	15	690	4	-	A
PT 22b3	1:1:1	300	0,6	0,6	3	4,5	40	800	0,8	15	690	4	4	B
PT 22c3	2:1	300	1	0,6	6	6,5	55	800	0,8	15	690	4	-	A
PT 22d3	3:1	300	1,5	0,6	26	20	65	800	0,8	15	690	4	-	A
PT 22e3	3:1:1	300	1,2	0,5	26	20	45	800	0,8	50	690	4	4	B
PT 22b4	1:1:1	400	0,8	0,8	5,5	10	55	800	1	15	690	4	4	B
PT 22a5	1:1	500	1	1	7,5	10	30	800	1	15	690	4	-	A
PT 22b5	1:1:1	500	1	1	7,7	10	45	800	1	15	690	4	4	B

# PT SERIES

## Pulse transformers designed for Semikron

### Electrical specifications

Code	NP : Ns	$\int Vdt$ ( $\mu V s$ )	$R_p$ TYP ( $\Omega$ )	$R_s$ TYP ( $\Omega$ )	$L_p$ (mH)	$L_{ss}$ MAX ( $\mu H$ )	CC (pF) TYP	$I_M$ (mA)	$t_r$ ( $\mu s$ )	$R_L$ ( $\Omega$ )	Vw (V)	Visol P/S (kVac)	Visol S/S (kVac)	Config
PT 25j2	2:2	200	0,8	1,5	1,27	20	7,5	450	4	50	500	5	3,5	1-G
PT 25a3	1:1	300	0,5	0,5	2	3	50	250	1	50	500	4	-	1-A
PT 25b3	1:1:1	300	0,5	0,5	2	3	60	250	1	50	500	4	4	1-B
PT 25e3	3:1:1	300	1,7	0,55	15,8	20	55	250	1	50	500	4	4	1-B
PT 25h3	1:1:1:1	300	0,55	0,55	2	5	65	250	1	50	500	4	4	1-C
PT 25k3	1:1:1	300	0,5	0,5	2	3	60	250	1	50	650	4	4	1-E
PT 25m3	1:1	300	0,5	0,5	1,8	50	10	200	2	50	1000	6	-	1-F
PT 25n3	3:1	300	1,7	0,55	15,8	400	10	200	2	50	1000	6	-	1-F
PT 25p3	3:1:1	300	1,7	0,55	15,8	20	45	250	1	50	650	4	4	1-E
PT 25a4	1:1	400	0,6	0,6	4,2	5	70	300	1	50	500	4	-	1-A
PT 25b4	1:1:1	400	0,6	0,6	4,2	5	60	300	1	50	500	4	4	1-B
PT 25b4/hs	1:1:1	400	0,9	0,9	2,2	5	70	300	1	50	700	4	4	1-D
PT 25g4	2:1:1	400	1,7	1	12,3	250	8,5	200	4	50	500	5	3,5	1-G
PT 25a5	1:1	500	1	1	5,5	15	40	400	1	50	500	4	-	1-A
PT 25b5	1:1:1	500	1	1	5,5	10	50	400	1	50	500	4	4	1-B
PT 25m5	1:1	500	1	1	5,5	125	8	250	5	50	1000	6	-	1-F
PT 25o5	2:1	500	2	1	31,7	500	8,5	250	5	50	1000	6	-	1-F
PT 25b6/N	1:1:1	650	1	1	5,7	15	70	500	1	50	600	4	4	1-B
PT 25b8	1:1:1	800	1,7	1,7	13,5	15	70	600	1,5	50	500	4	4	1-B
PT 25b10	1:1:1	1000	1,8	1,8	18,3	25	55	700	1,5	50	500	4	4	1-B
PT 25b20	1:1:1	2000	6,8	6,8	56	65	70	800	2	50	500	4	4	1-B
PT 909	1:1	400	0,9	0,9	4,2	5	50	300	1	50	900	3	-	2-A
PT 26a3	1:1	300	0,55	0,55	2	5	50	250	1	50	500	4	-	A
PT 26b3	1:1:1	300	0,55	0,55	2	5	60	250	1	50	500	4	4	B
PT 26e3	3:1:1	300	1,8	0,5	14,7	25	50	250	1	50	500	4	4	B
PT 26b10	1:1:1	1000	2,3	2,3	18,3	25	50	700	2,5	50	500	4	4	B
PT26n3	3:1	300	1,7	0,70	15,8	400	30	200	2	50	1000	6	-	C
PT 27a3	1:1	300	0,3	0,3	2	2	70	1200	1	10	690	4	-	A
PT 27b3	1:1:1	300	0,3	0,3	2	2	70	1200	1	10	690	4	4	B
PT 27d3,5	3:1	350	0,6	0,3	19,7	10	120	2000	1	5	690	4	-	A
PT 27e3,5	3:1:1	350	0,6	0,3	19,7	7	100	2000	1	5	690	4	4	B
PT 27b4/1300	1:1:1	450	0,15	0,15	0,55	4	40	2000	1	10	1300	6	5	B
PT 27a5	1:1	500	0,4	0,4	5	8	105	2000	1	10	690	4	4	A
PT 27b5	1:1:1	500	0,4	0,4	5	8	120	2000	1	10	690	4	4	B
PT 27a10	1:1	1000	0,4	0,4	2,2	8	160	2000	1,5	10	690	4	4	A
PT 27b10	1:1:1	1000	0,5	0,5	2,2	8	100	2000	1,5	10	690	4	4	B
PT 27b10ES	1:1:1	1000	0,5	0,5	2,2	20	60	2000	1,5	10	690	4	4	C
PT 27c10	2:1	1000	0,7	0,35	10	23	180	2000	1	10	690	4	4	A
PT HVb3	1:1:1	300	0,3	0,3	2,8	75	15	1000	1	50	3200	12	12	A

# PT SERIES

## Pulse transformers designed for Semikron

Pulse Transformers

### Winding configurations and dimensions

#### PT-14 SERIES

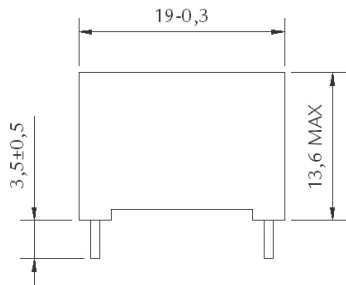

Configuration A

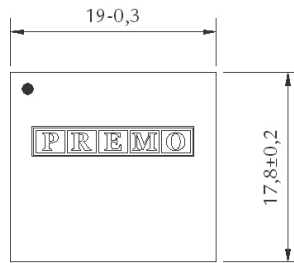

Configuration C

View by the side of the pins

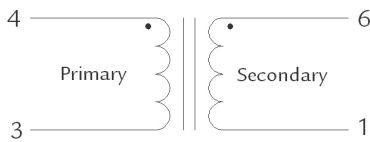
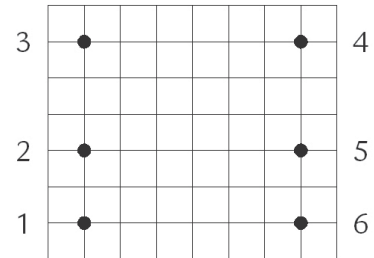

Configuration B

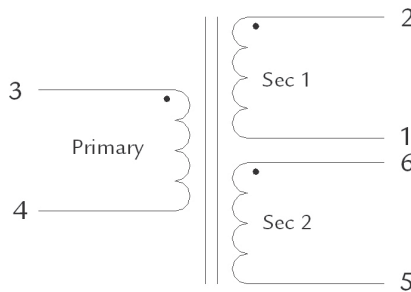

Configuration D

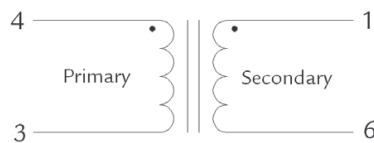
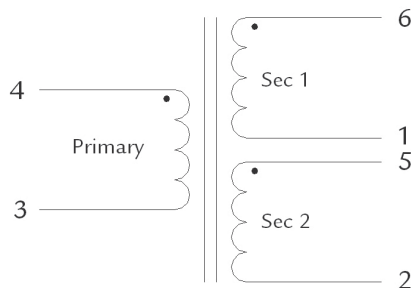

#### PT-22 SERIES

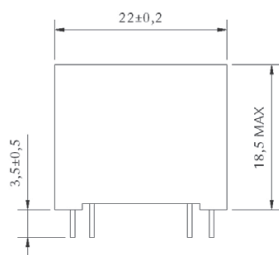

Configuration A

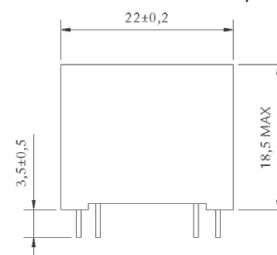
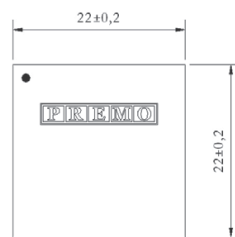

View by the side of the pins

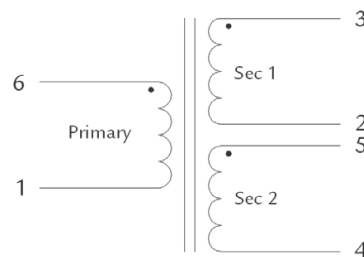
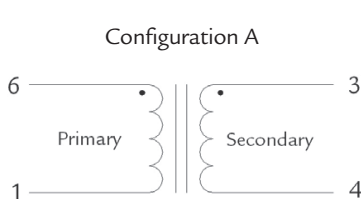
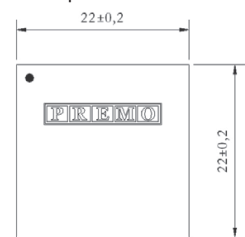

Configuration B

All dimensions in mm; Pin diameter = 0,6mm typ; Pins with no connection are removed; Grid = 2,5mm unless otherwise indicated; Pin grid tolerance = ±0,2mm; Dot on the top indicating pin number 1.

# PT SERIES

Pulse transformers designed for Semikron

## Winding configurations and dimensions

PT-25 SERIES

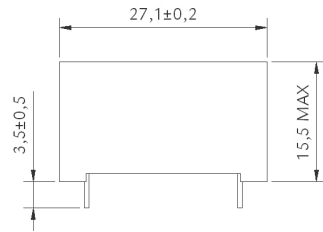

1 - Configuration

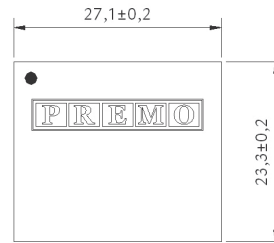

2 - Configuration  
Special raster 2,54 mm

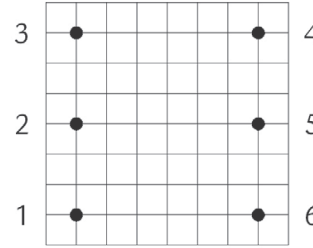
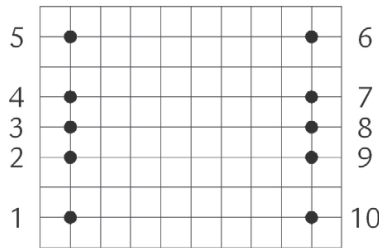

View by the side of the pins

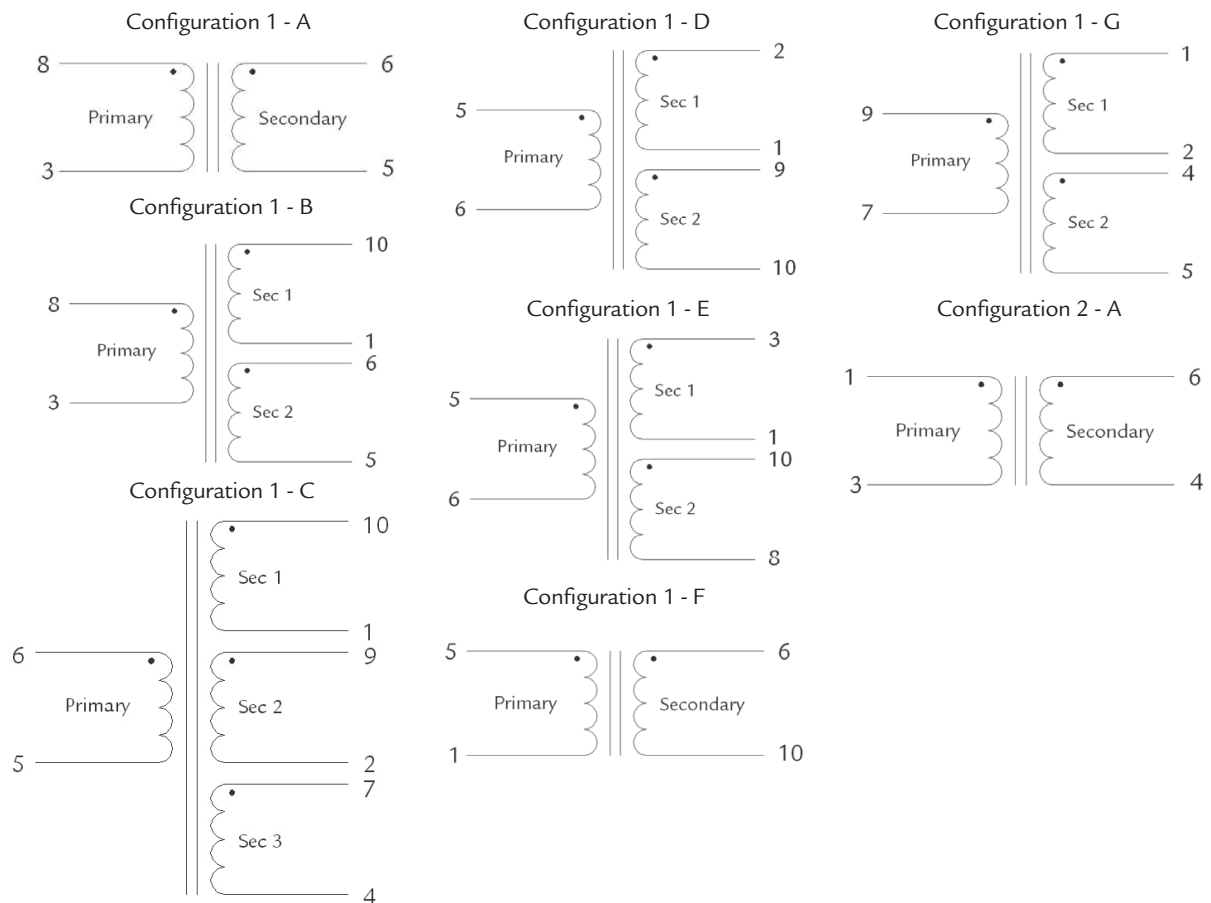

All dimensions in mm; Pin diameter = 0,6mm typ; Pins with no connection are removed; Grid = 2,5mm unless otherwise indicated; Pin grid tolerance = ±0,2mm; Dot on the top indicating pin number 1.

## PT SERIES

Pulse transformers designed for Semikron

### Winding configurations and dimensions

#### PT-26 SERIES

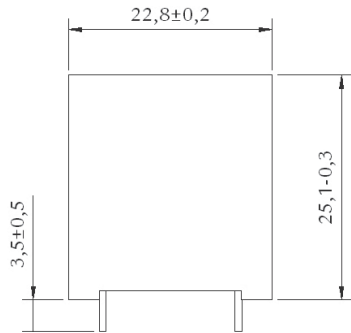

Configuration A

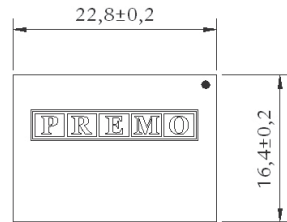

Configuration B

View by the side of the pins

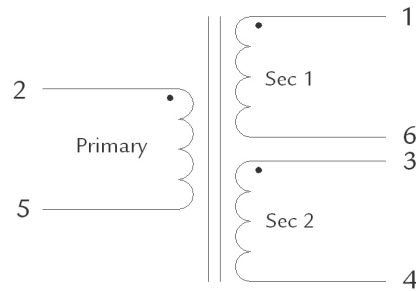
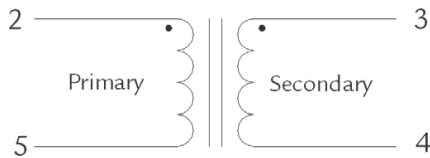
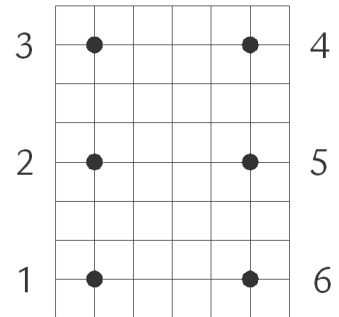

#### PT-27 SERIES

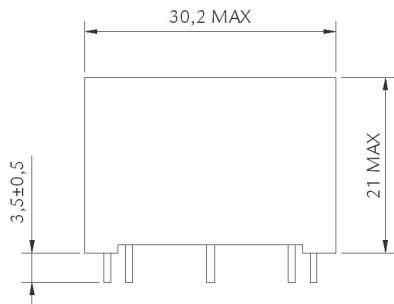

Configuration A

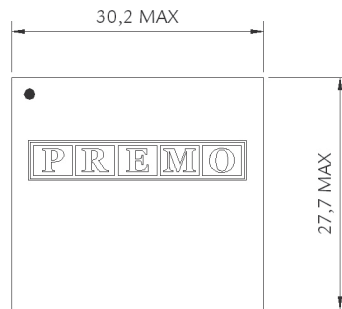

Configuration B

Shield pin number 7  $\varnothing$ 0,8mm  
View by the side of the pins

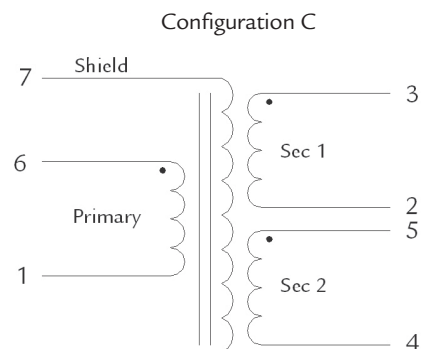
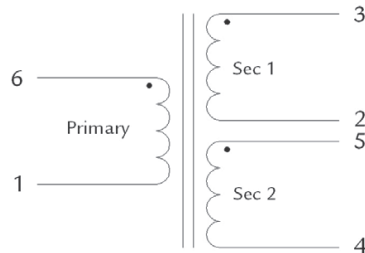
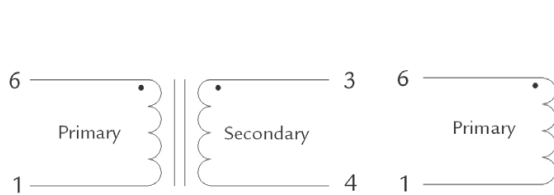
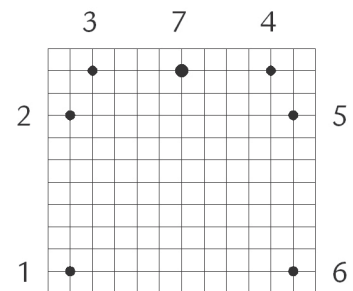

All dimensions in mm; Pin diameter = 0,6mm typ; Pins with no connection are removed; Grid = 2,5mm unless otherwise indicated; Pin grid tolerance =  $\pm$ 0,2mm; Dot on the top indicating pin number 1.

# PT SERIES

Pulse transformers designed for Semikron

## Winding configurations and dimensions

PT-HV

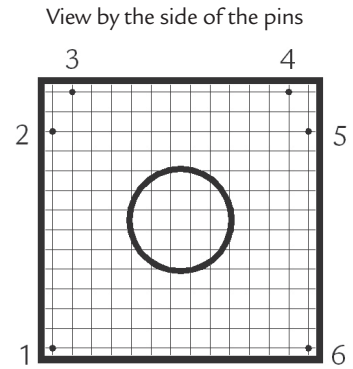
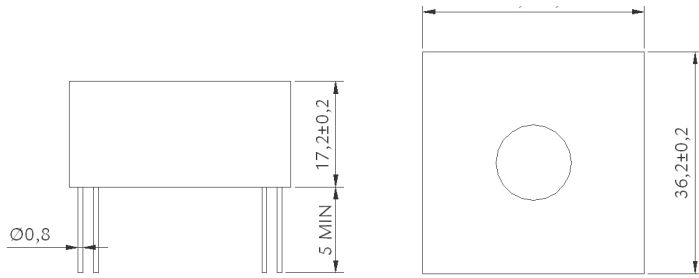

Configuration A

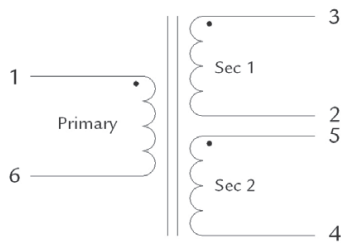

All dimensions in mm; Pin diameter = 0,6mm typ; Pins with no connection are removed; Grid = 2,5mm unless otherwise indicated; Pin grid tolerance = ±0,2mm; Dot on the top indicating pin number 1.