

### 39 $\mu$ A Micropower Single and Dual Rail-to-Rail Input-Output Low Input Bias Current (RRIO) Op Amps

The ISL28166 and ISL28266 are micropower precision operational amplifiers optimized for single supply operation at 5V and can operate down to 2.4V.

These devices feature an Input Range Enhancement Circuit (IREC), which enables them to maintain CMRR performance for input voltages greater than the positive supply. The input signal is capable of swinging 0.5V above a 5.0V supply (0.25 for a 2.5V supply) and to within 10mV from ground. The output operation is rail-to-rail.

The 1/f corner of the voltage noise spectrum is at 1kHz. This results in low frequency noise performance, which can only be found on devices with an order of magnitude higher than the supply current.

ISL28166 and ISL28266 can be operated from one lithium cell or two Ni-Cd batteries. The input range includes both positive and negative rail. The output swings to both rails.

### Ordering Information

| PART NUMBER<br>(Note) | PART MARKING | PACKAGE<br>(Pb-Free) | PKG. DWG. # |
|-----------------------|--------------|----------------------|-------------|
| ISL28166FHZ-T7*       | GABY         | 6 Ld SOT-23          | MDP0038     |
| ISL28266FUZ           | 8266Z        | 8 Ld MSOP            | MDP0043     |
| ISL28266FUZ-T7*       | 8266Z        | 8 Ld MSOP            | MDP0043     |
| ISL28266FBZ           | 28266 FBZ    | 8 Ld SOIC            | MDP0027     |
| ISL28266FBZ-T7*       | 28266 FBZ    | 8 Ld SOIC            | MDP0027     |

\*Please refer to TB347 for details on reel specifications.

NOTE: These Intersil Pb-free plastic packaged products employ special Pb-free material sets, molding compounds/die attach materials, and 100% matte tin plate plus anneal (e3 termination finish, which is RoHS compliant and compatible with both SnPb and Pb-free soldering operations). Intersil Pb-free products are MSL classified at Pb-free peak reflow temperatures that meet or exceed the Pb-free requirements of IPC/JEDEC J STD-020.

### Features

- 39 $\mu$ A typical supply current (ISL28166)
- 78 $\mu$ A typical supply current (ISL28266)
- 5nA max input bias current
- 250kHz gain bandwidth product ( $A_v = 1$ )
- 2.4V to 5V single supply voltage range
- Rail-to-rail input and output
- Enable pin (ISL28166 only)
- Pb-free (RoHS compliant)

### Applications

- Battery- or solar-powered systems
- 4mA to 20mA current loops
- Handheld consumer products
- Medical devices
- Sensor amplifiers
- ADC buffers
- DAC output amplifiers

### Pinouts

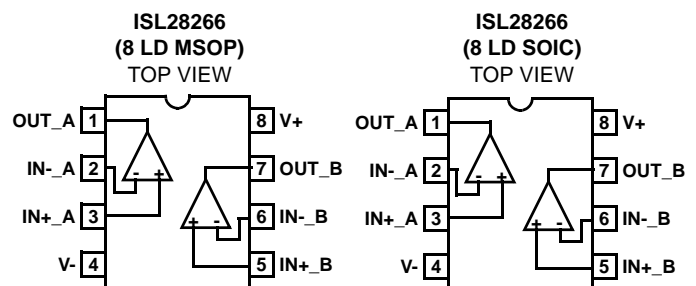
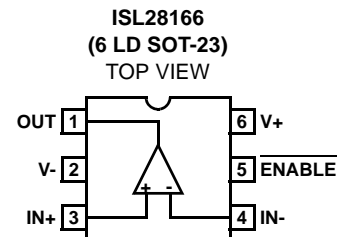

**Absolute Maximum Ratings** ( $T_A = +25^\circ\text{C}$ )

|                                  |                        |
|----------------------------------|------------------------|
| Supply Voltage                   | 5.5V                   |
| Supply Turn-on Voltage Slew Rate | 1V/ $\mu\text{s}$      |
| Differential Input Current       | 5mA                    |
| Differential Input Voltage       | 0.5V                   |
| Input Voltage                    | V- - 0.5V to V+ + 0.5V |
| ESD Rating                       |                        |
| Human Body Model                 | .3kV                   |
| Machine Model                    | .300V                  |
| Charged Device Model             | 1500V                  |

**Thermal Information**

|                                     |   |
|-------------------------------------|---|
| Thermal Resistance (Typical Note 1) | $\theta_{JA}$ ( $^\circ\text{C}/\text{W}$ )   |
| 6 Ld SOT-23 Package                 | 230   |
| 8 Ld MSOP Package                   | 160   |
| 8 Ld SOIC Package                   | 120   |
| Output Short-Circuit Duration       | Indefinite  |
| Ambient Operating Temperature Range | -40 $^\circ\text{C}$ to +125 $^\circ\text{C}$   |
| Storage Temperature Range           | -65 $^\circ\text{C}$ to +150 $^\circ\text{C}$   |
| Operating Junction Temperature      | +125 $^\circ\text{C}$   |
| Pb-free reflow profile              | see link below  |
|                                     | <a href="http://www.intersil.com/pbfree/Pb-FreeReflow.asp">http://www.intersil.com/pbfree/Pb-FreeReflow.asp</a> |

CAUTION: Do not operate at or near the maximum ratings listed for extended periods of time. Exposure to such conditions may adversely impact product reliability and result in failures not covered by warranty.

NOTE:

- $\theta_{JA}$  is measured with the component mounted on a high effective thermal conductivity test board in free air. See Tech Brief TB379 for details.

IMPORTANT NOTE: All parameters having Min/Max specifications are guaranteed. Typical values are for information purposes only. Unless otherwise noted, all tests are at the specified temperature and are pulsed tests, therefore:  $T_J = T_C = T_A$

**Electrical Specifications**  $V_+ = 5\text{V}, V_- = 0\text{V}, V_{CM} = 2.5\text{V}, T_A = +25^\circ\text{C}$  unless otherwise specified. **Boldface limits apply over the operating temperature range, -40 $^\circ\text{C}$  to +125 $^\circ\text{C}$ .** Temperature data established by characterization.

| PARAMETER                        | DESCRIPTION                       | CONDITIONS   | MIN<br>(Note 2)      | TYP   | MAX<br>(Note 2)   | UNIT                         |
|----------------------------------|-----------------------------------|--|----------------------|-------|-------------------|------------------------------|
| $V_{OS}$                         | Input Offset Voltage              |  | -700<br><b>-800</b>  | -7    | 700<br><b>800</b> | $\mu\text{V}$                |
| $\frac{\Delta V_{OS}}{\Delta T}$ | Input Offset Drive vs Temperature |  |                      | 1.5   |                   | $\mu\text{V}/^\circ\text{C}$ |
| $I_{OS}$                         | Input Offset Current              |  | -1.5<br><b>-5</b>    | 0.34  | 1.2<br><b>2.5</b> | nA                           |
| $I_B$                            | Input Bias Current                |  | -5<br><b>-5.5</b>    | 1.14  | 5<br><b>5.5</b>   | nA                           |
| $E_N$                            | Input Noise Voltage Density       | $F_O = 1\text{kHz}$  |                      | 46    |                   | $\text{nV}/\sqrt{\text{Hz}}$ |
| $I_N$                            | Input Noise Current Density       | $F_O = 1\text{kHz}$  |                      | 0.14  |                   | $\text{pA}/\sqrt{\text{Hz}}$ |
| CMIR                             | Input Common-Mode Voltage Range   |  | 0                    |       | 5                 | V                            |
| CMRR                             | Common-Mode Rejection Ratio       | $V_{CM} = 0\text{V to } 5\text{V}$                           | 80<br><b>75</b>      | 110   |                   | dB                           |
| PSRR                             | Power Supply Rejection Ratio      | $V_S = 2.4\text{V to } 5\text{V}$                            | 90<br><b>75</b>      | 104   |                   | dB                           |
| $A_{VOL}$                        | Large Signal Voltage Gain         | $V_O = 0.5\text{V to } 4.5\text{V}, R_L = 100\text{k}\Omega$ | 200<br><b>175</b>    | 412   |                   | V/mV                         |
|                                  |                                   | $V_O = 0.5\text{V to } 4.5\text{V}, R_L = 1\text{k}\Omega$   | 35<br><b>30</b>      | 70    |                   | V/mV                         |
| $V_{OUT}$                        | Maximum Output Voltage Swing      | Output low, $R_L = 100\text{k}\Omega$                        |                      | 3     | 6<br><b>8</b>     | mV                           |
|                                  |                                   | Output low, $R_L = 1\text{k}\Omega$                          |                      | 130   | 150<br><b>200</b> | mV                           |
|                                  |                                   | Output high, $R_L = 100\text{k}\Omega$                       | 4.992<br><b>4.99</b> | 4.995 |                   | V                            |
|                                  |                                   | Output high, $R_L = 1\text{k}\Omega$                         | 4.85<br><b>4.8</b>   | 4.88  |                   | V                            |
| SR                               | Slew Rate                         |  |                      | 0.05  |                   | V/ $\mu\text{s}$             |
| GBW                              | Gain Bandwidth Product            | $A_V = 1$  |                      | 250   |                   | kHz                          |

# ISL28166, ISL28266

**Electrical Specifications**  $V_+ = 5V, V_- = 0V, V_{CM} = 2.5V, T_A = +25^\circ C$  unless otherwise specified. **Boldface limits apply over the operating temperature range,  $-40^\circ C$  to  $+125^\circ C$ .** Temperature data established by characterization. (Continued)

| PARAMETER    | DESCRIPTION                                      | CONDITIONS   | MIN (Note 2)    | TYP  | MAX (Note 2)      | UNIT    |
|--------------|--|--|-----------------|------|-------------------|---------|
| $I_{S,ON}$   | Supply Current, Enabled (ISL28166)               |  |                 | 39   | 47<br><b>56</b>   | $\mu A$ |
| $I_{S,ON}$   | Supply Current (ISL28266)                        |  |                 | 78   | 94<br><b>112</b>  | $\mu A$ |
| $I_{S,OFF}$  | Supply Current, Disabled (ISL28166)              |  |                 | 10   | 14<br><b>16</b>   | $\mu A$ |
| $I_{O+}$     | Short-Circuit Output Current                     | $R_L = 10\Omega$                                       | 28<br><b>23</b> | 31   |                   | mA      |
| $I_{O-}$     | Short-Circuit Output Current                     | $R_L = 10\Omega$                                       |                 | -26  | -24<br><b>-18</b> | mA      |
| $V_{SUPPLY}$ | Supply Operating Range                           | Guaranteed by PSRR test                                | 2.4             |      | 5                 | V       |
| $V_{INH}$    | Enable Pin High Level (ISL28166)                 |  | <b>2</b>        |      |                   | V       |
| $V_{INL}$    | Enable Pin Low Level (ISL28166)                  |  |                 |      | <b>0.8</b>        | V       |
| $I_{ENH}$    | Enable Pin Input Current (ISL28166)              | $V_{EN} = 5V$  |                 | 1    | 1.2<br><b>1.2</b> | $\mu A$ |
| $I_{ENL}$    | Enable Pin Input Current (ISL28166)              | $V_{EN} = 0V$  |                 | 16   | 25<br><b>30</b>   | nA      |
| $t_{EN}$     | Enable to output on-state delay time (ISL28166)  | $V_{OUT} = 1V$ (enable state); $V_{EN} =$ High to Low  |                 | 10.8 |                   | $\mu s$ |
| $t_{EN}$     | Enable to output off-state delay time (ISL28166) | $V_{OUT} = 0V$ (disabled state) $V_{EN} =$ Low to High |                 | 0.1  |                   | $\mu s$ |

NOTE:

- Parameters with MIN and/or MAX limits are 100% tested at  $+25^\circ C$ , unless otherwise specified. Temperature limits established by characterization and are not production tested.

## Typical Performance Curves

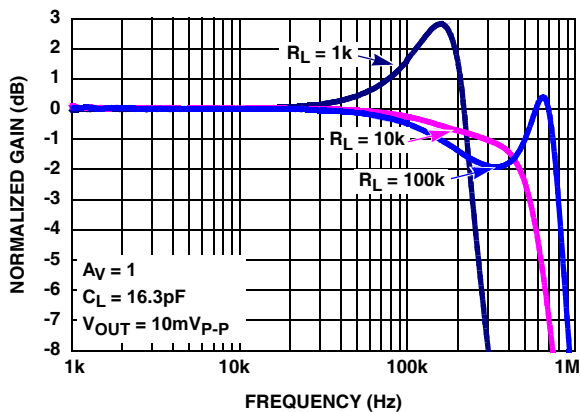

FIGURE 1. GAIN vs FREQUENCY vs  $R_L$

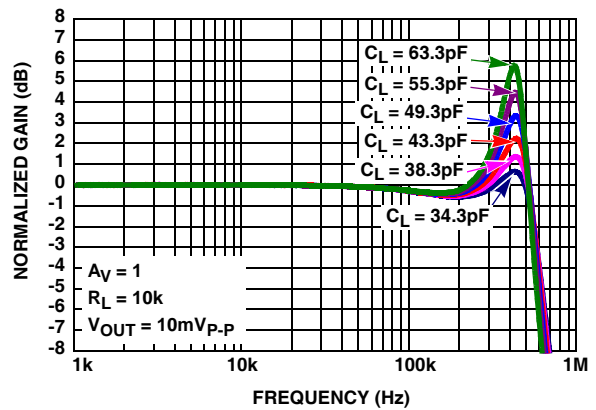

FIGURE 2. GAIN vs FREQUENCY vs  $C_L$

Typical Performance Curves (Continued)

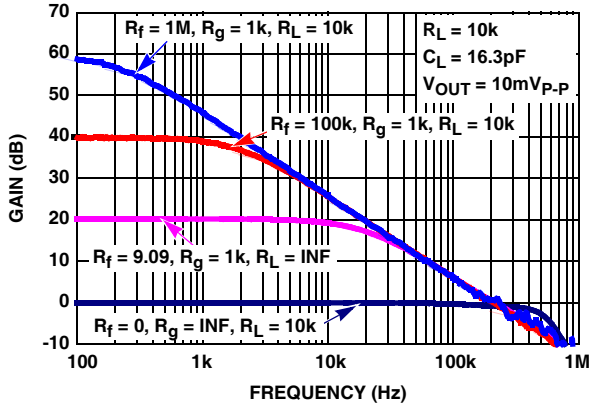

FIGURE 3. CLOSED LOOP GAIN vs FREQUENCY

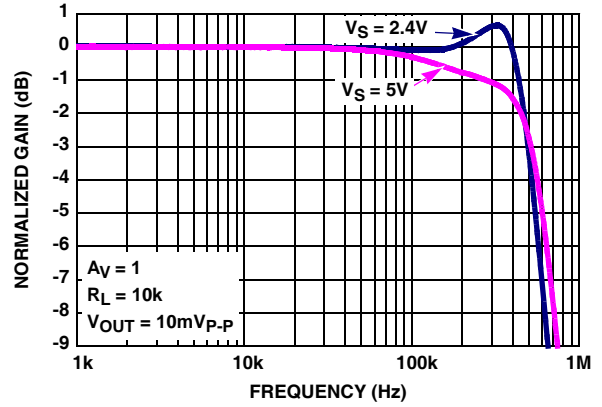

FIGURE 4. GAIN vs FREQUENCY vs  $V_S$

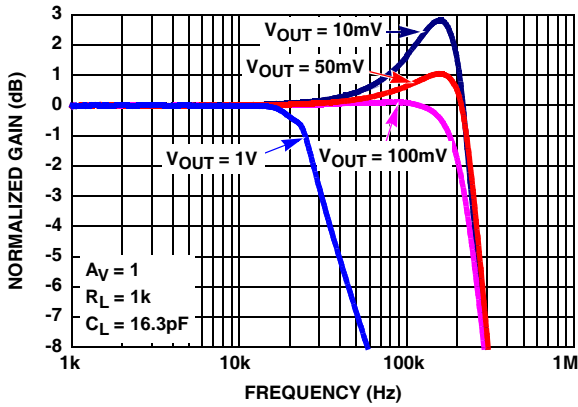

FIGURE 5. GAIN vs FREQUENCY vs  $V_{OUT}$

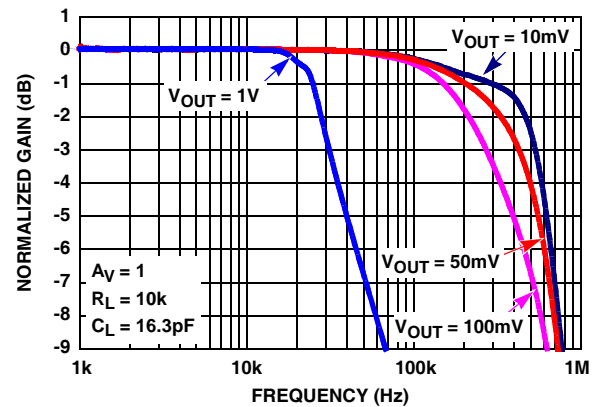

FIGURE 6. GAIN vs FREQUENCY vs  $V_{OUT}$

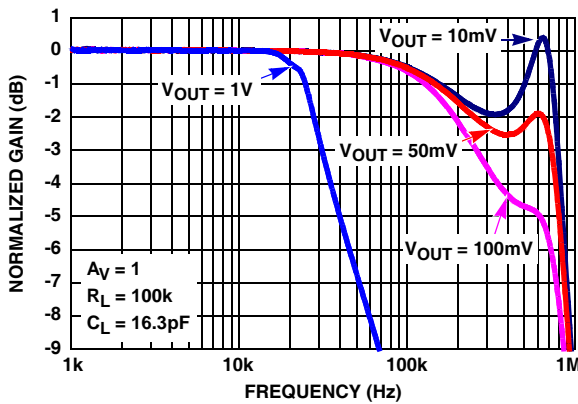

FIGURE 7. GAIN vs FREQUENCY vs  $V_{OUT}$

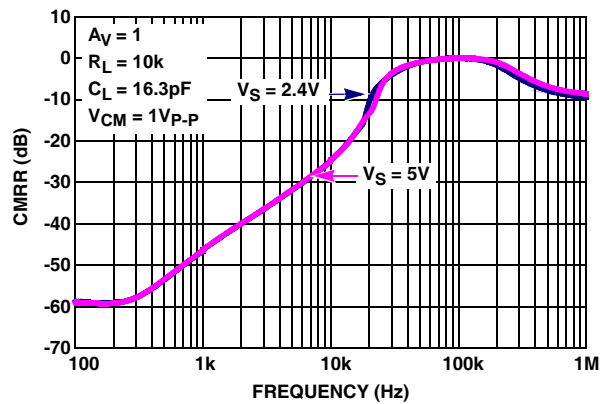

FIGURE 8. CMRR vs FREQUENCY

Typical Performance Curves (Continued)

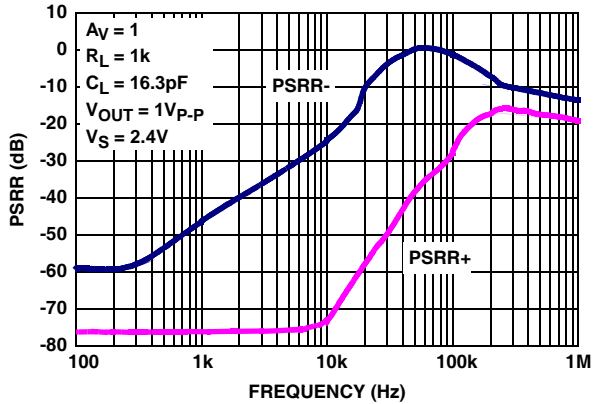

FIGURE 9. PSRR vs FREQUENCY,  $V_S = 2.4V$

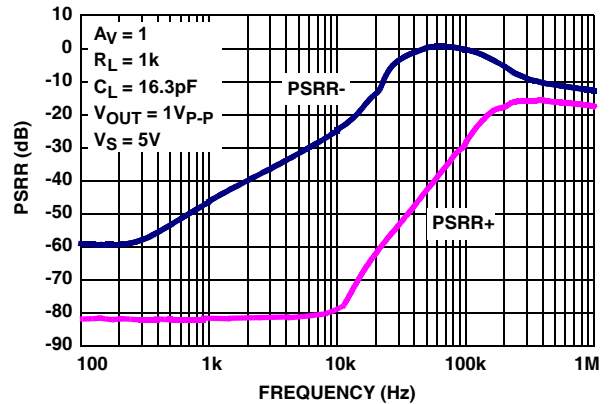

FIGURE 10. PSRR vs FREQUENCY,  $V_S = 5V$

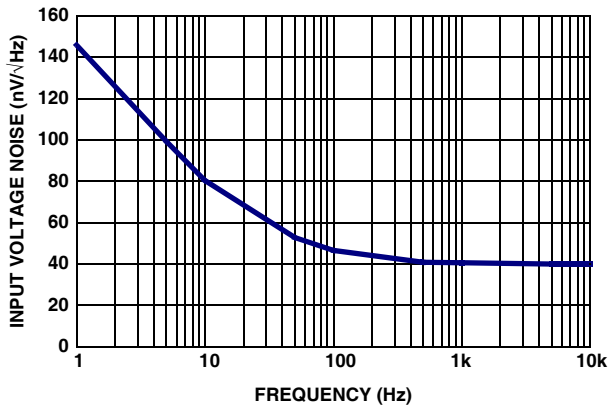

FIGURE 11. INPUT VOLTAGE NOISE vs FREQUENCY

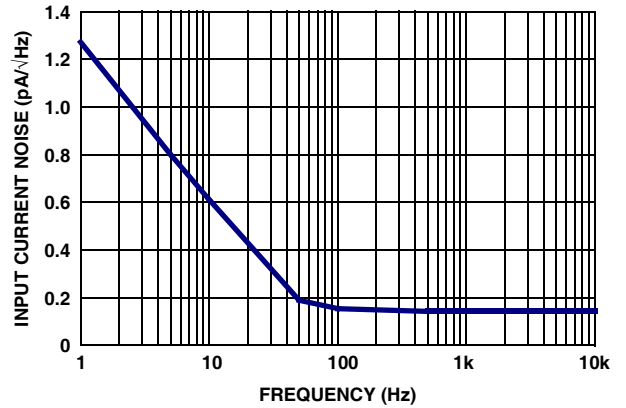

FIGURE 12. INPUT CURRENT NOISE vs FREQUENCY

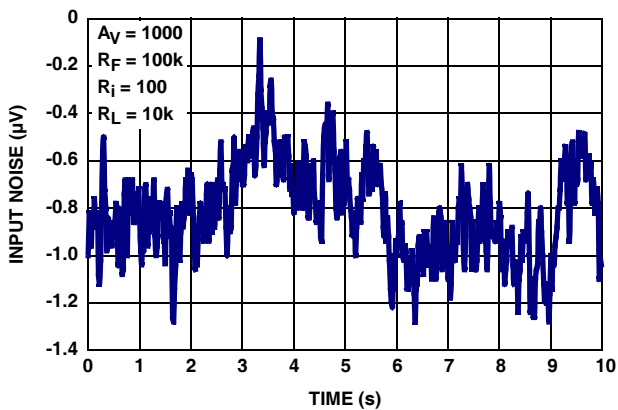

FIGURE 13. 1Hz TO 10Hz INPUT NOISE

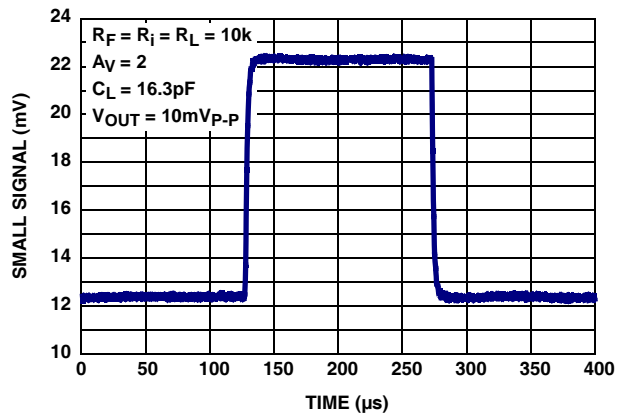

FIGURE 14. SMALL SIGNAL STEP RESPONSE

Typical Performance Curves (Continued)

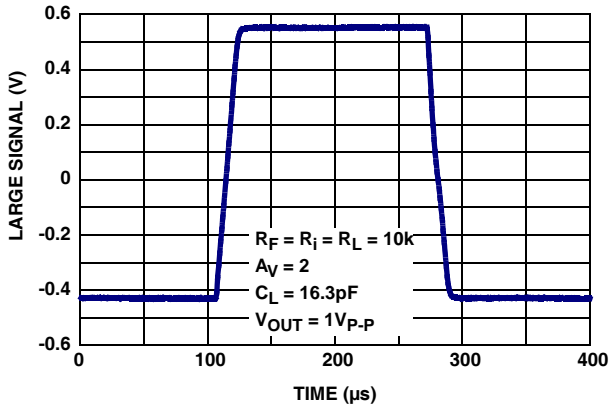

FIGURE 15. LARGE SIGNAL STEP RESPONSE

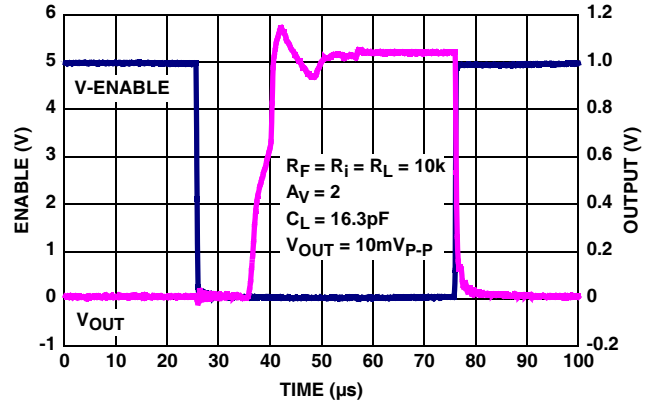

FIGURE 16. ENABLE TO OUTPUT DELAY

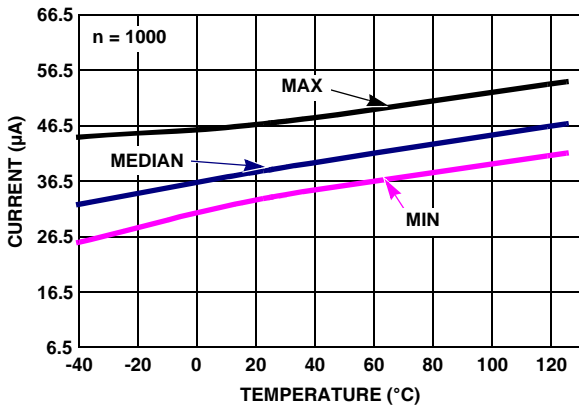

FIGURE 17. SUPPLY CURRENT ENABLED (SINGLE) vs TEMPERATURE,  $V_S = \pm 2.5V$

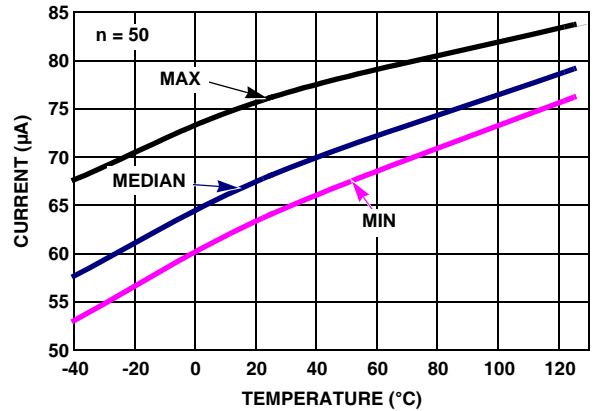

FIGURE 18. SUPPLY CURRENT ENABLED (DUAL) vs TEMPERATURE,  $V_S = \pm 2.5V$

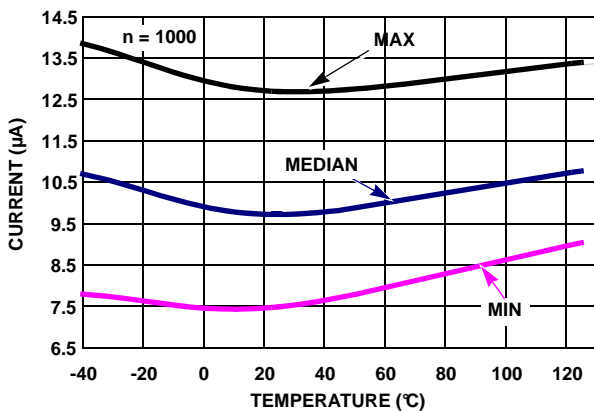

FIGURE 19. SUPPLY CURRENT DISABLED (SINGLE) vs TEMPERATURE,  $V_S = \pm 2.5V$

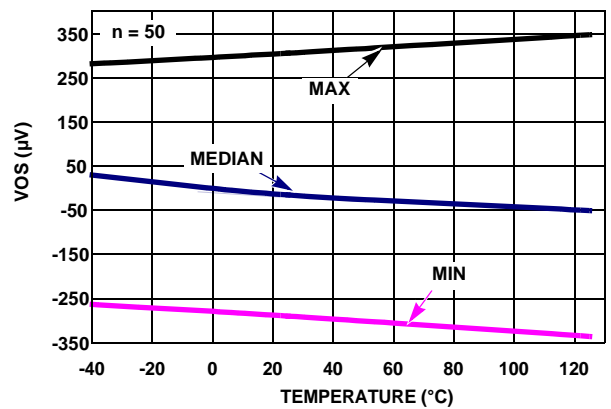

FIGURE 20. VOS vs TEMPERATURE,  $V_S = \pm 2.5V$

Typical Performance Curves (Continued)

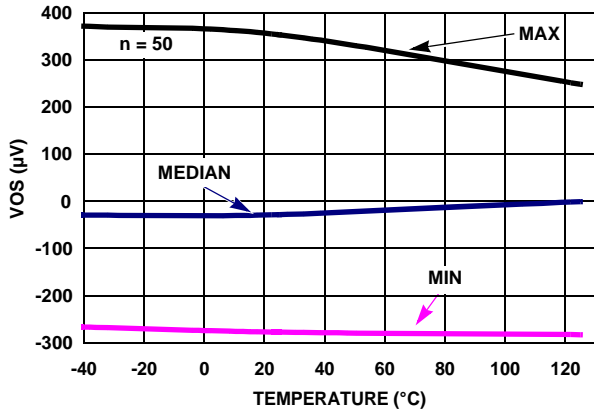

FIGURE 21. VOS vs TEMPERATURE,  $V_S = \pm 1.2V$

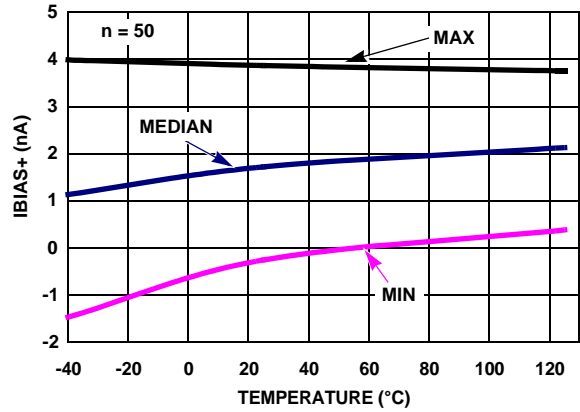

FIGURE 22.  $I_{BIAS+}$  vs TEMPERATURE,  $V_S = \pm 2.5V$

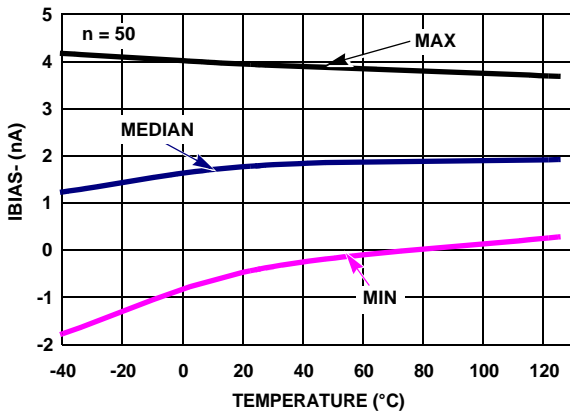

FIGURE 23.  $I_{BIAS-}$  vs TEMPERATURE,  $V_S = \pm 2.5V$

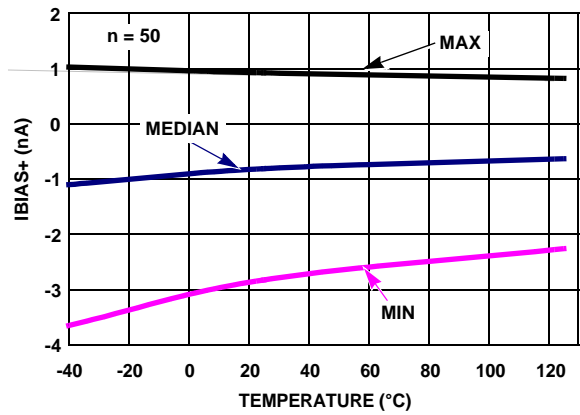

FIGURE 24.  $I_{BIAS+}$  vs TEMPERATURE,  $V_S = \pm 1.2V$

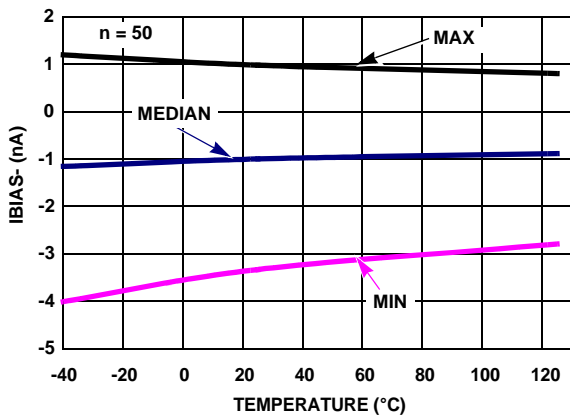

FIGURE 25.  $I_{BIAS-}$  vs TEMPERATURE,  $V_S = \pm 1.2V$

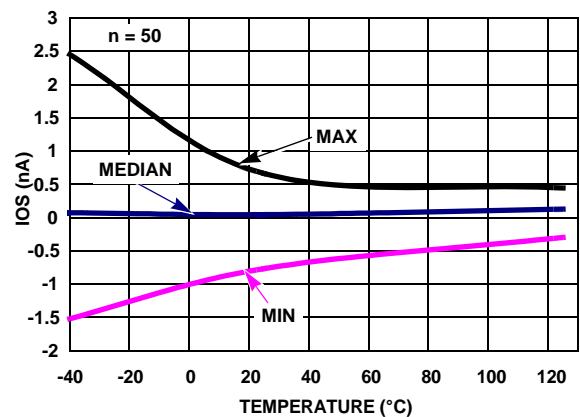

FIGURE 26. IOS vs TEMPERATURE,  $V_S = \pm 2.5V$

Typical Performance Curves (Continued)

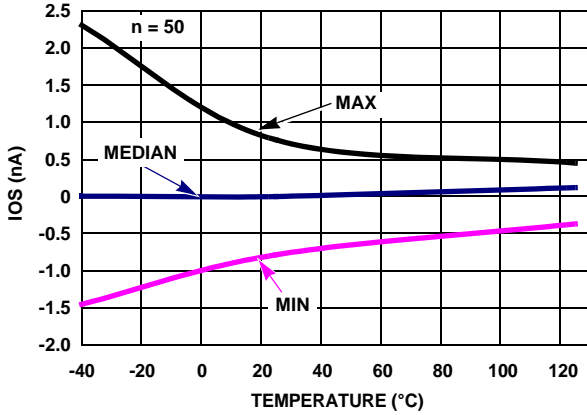

FIGURE 27. IOS vs TEMPERATURE,  $V_S = \pm 1.2V$

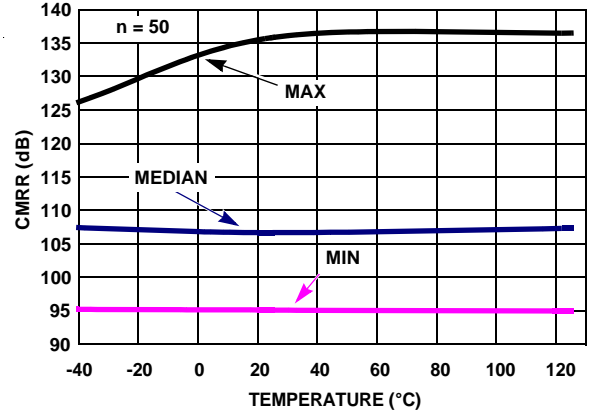

FIGURE 28. CMRR vs TEMPERATURE  $V_{+} = \pm 2.5V, \pm 1.5V$

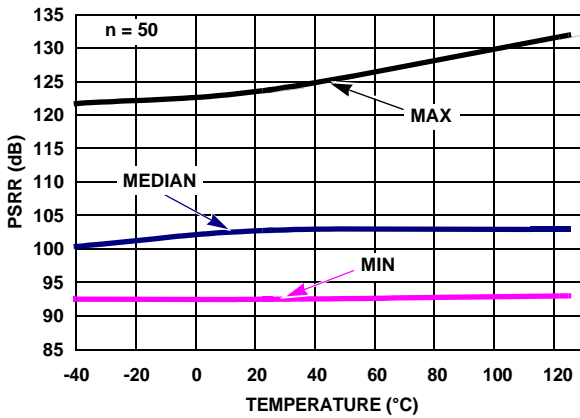

FIGURE 29. PSRR vs TEMPERATURE  $\pm 1.2V$  TO  $\pm 2.5V$

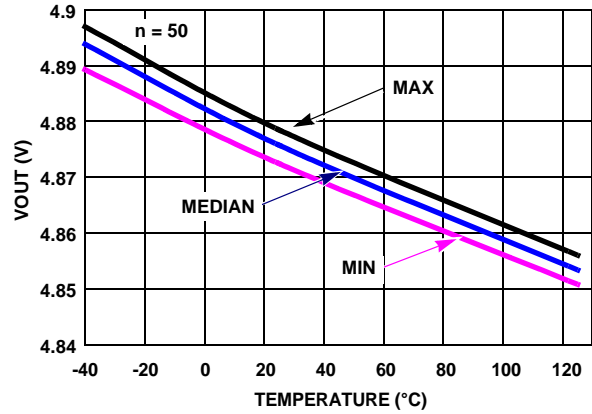

FIGURE 30.  $V_{OUT}$  HIGH vs TEMP  $V_S = \pm 2.5V, R_L = 1k$

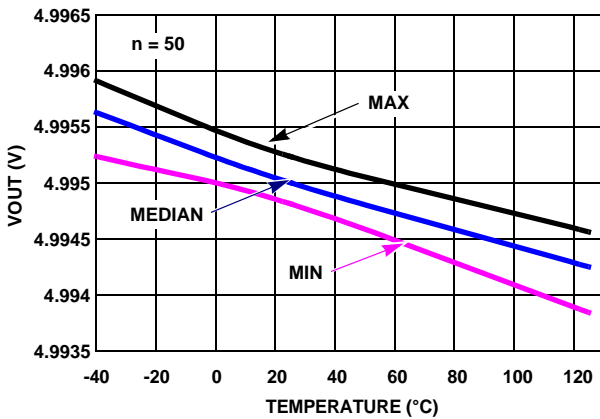

FIGURE 31.  $V_{OUT}$  HIGH  $V_S = \pm 2.5V, R_L = 100k$

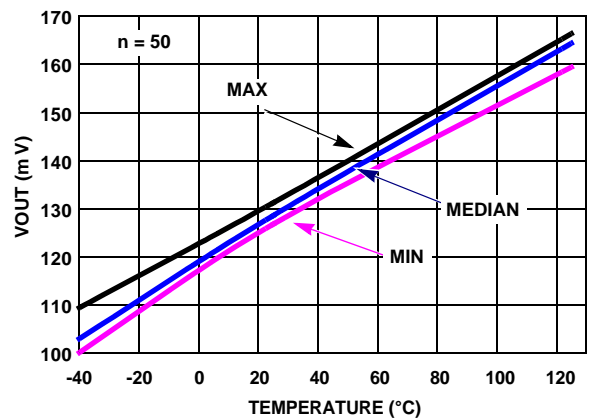

FIGURE 32.  $V_{OUT}$  LOW  $V_S = \pm 2.5V, R_L = 1k$



Typical Performance Curves (Continued)

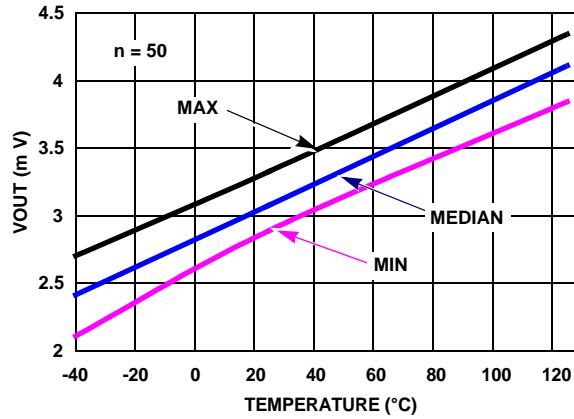

FIGURE 33.  $V_{OUT}$  LOW  $V_S = \pm 2.5V$ ,  $R_L = 100k$

Pin Descriptions

| ISL28166<br>(6 Ld SOT-23) | ISL28266<br>(8 Ld SOIC)<br>(8 Ld MSOP) | PIN NAME              | FUNCTION            | EQUIVALENT CIRCUIT |
|---------------------------|--|-----------------------|---------------------|--------------------|
| 4                         | 2 (A)<br>6 (B)                         | IN-<br>IN-_A<br>IN-_B | Inverting input     | <br>Circuit 1      |
| 3                         | 3 (A)<br>5 (B)                         | IN+<br>IN+_A<br>IN+_B | Non-inverting input | (See Circuit 1)    |
| 2                         | 4                                      | V-                    | Negative supply     |                    |
| 1                         | 1 (A)<br>7 (B)                         | OUT<br>OUT_A<br>OUT_B | Output              | <br>Circuit 2      |
| 6                         | 8                                      | V+                    | Positive supply     |                    |
| 5                         |  | ENABLE                | Chip enable         | <br>Circuit 3      |

## Applications Information

### Introduction

The ISL28166 is a single BiMOS rail-to-rail input, output (RRIO) operational amplifier with an enable feature. The ISL28266 is a dual version without the enable feature. Both devices are designed to operate from single supply (2.4V to 5.0V) or dual supplies ( $\pm 1.2V$  to  $\pm 2.5V$ ) while drawing only 39 $\mu A$  of supply current per amplifier. This combination of low power and precision performance makes this device suitable for a variety of low power applications including battery powered systems.

### Rail-to-Rail Input/Output

These devices feature bi-polar inputs which have an input common mode range that extends to the rails, and CMOS outputs that can typically swing to within about 4mV of the supply rails with a 100k $\Omega$  load. The NMOS sinks current to swing the output in the negative direction. The PMOS sources current to swing the output in the positive direction.

### Input Protection

All input terminals have internal ESD protection diodes to both positive and negative supply rails, limiting the input voltage to within one diode beyond the supply rails. They also contain back-to-back diodes across the input terminals. For applications where the input differential voltage is expected to exceed 0.5V, external series resistors must be used to ensure the input currents never exceed 5mA (Figure 34).

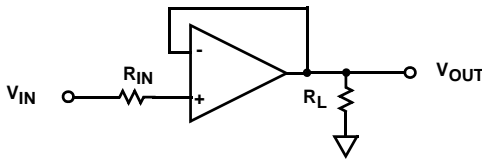

FIGURE 34. INPUT CURRENT LIMITING

### Enable/Disable Feature

The ISL28166 offers an  $\overline{EN}$  pin that disables the device when pulled up to at least 2.0V. In the disabled state (output in a high impedance state), the part consumes typically 10 $\mu A$ . By disabling the part, multiple ISL28166 parts can be connected together as a MUX. In this configuration, the outputs are tied together in parallel and a channel can be selected by the  $\overline{EN}$  pin. The  $\overline{EN}$  pin also has an internal pull-down. If left open, the  $\overline{EN}$  pin will pull to the negative rail and the device will be enabled by default.

The loading effects of the feedback resistors of the disabled amplifier must be considered when multiple amplifier outputs are connected together.

### Using Only One Channel

The ISL28266 is a dual op amp. If the application only requires one channel, the user must configure the unused channel to prevent it from oscillating. The unused channel will oscillate if the input and output pins are floating. This will

result in higher than expected supply currents and possible noise injection into the channel being used. The proper way to prevent this oscillation is to short the output to the negative input and ground the positive input (as shown in Figure 35).

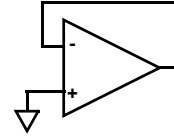

FIGURE 35. PREVENTING OSCILLATIONS IN UNUSED CHANNELS

### Current Limiting

These devices have no internal current-limiting circuitry. If the output is shorted, it is possible to exceed the Absolute Maximum Rating for output current or power dissipation, potentially resulting in the destruction of the device.

### Power Dissipation

It is possible to exceed the +125 $^{\circ}C$  maximum junction temperatures under certain load and power-supply conditions. It is therefore important to calculate the maximum junction temperature ( $T_{JMAX}$ ) for all applications to determine if power supply voltages, load conditions, or package type need to be modified to remain in the safe operating area. These parameters are related in Equation 1:

$$T_{JMAX} = T_{MAX} + (\theta_{JA} \times PD_{MAXTOTAL}) \quad (EQ. 1)$$

where:

- $PD_{MAXTOTAL}$  is the sum of the maximum power dissipation of each amplifier in the package ( $PD_{MAX}$ )
- $PD_{MAX}$  for each amplifier can be calculated using Equation 2:

$$PD_{MAX} = 2 \times V_S \times I_{SMAX} + (V_S - V_{OUTMAX}) \times \frac{V_{OUTMAX}}{R_L} \quad (EQ. 2)$$

where:

- $T_{MAX}$  = Maximum ambient temperature
- $\theta_{JA}$  = Thermal resistance of the package
- $PD_{MAX}$  = Maximum power dissipation of 1 amplifier
- $V_S$  = Supply voltage
- $I_{SMAX}$  = Maximum supply current of 1 amplifier
- $V_{OUTMAX}$  = Maximum output voltage swing of the application
- $R_L$  = Load resistance

SOT-23 Package Family

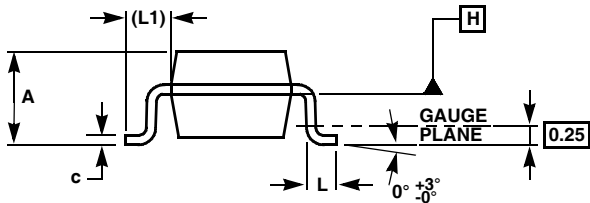
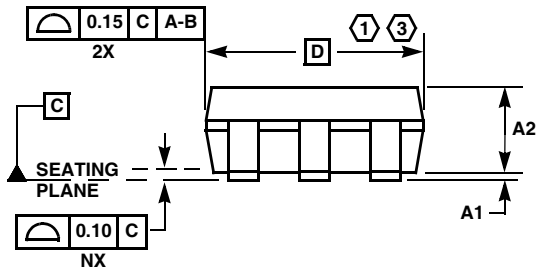
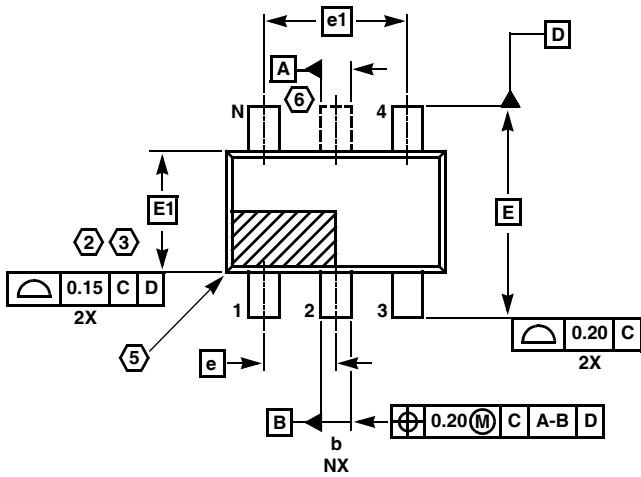

MDP0038

SOT-23 PACKAGE FAMILY

| SYMBOL | MILLIMETERS |         | TOLERANCE |
|--------|-------------|---------|-----------|
|        | SOT23-5     | SOT23-6 |           |
| A      | 1.45        | 1.45    | MAX       |
| A1     | 0.10        | 0.10    | ±0.05     |
| A2     | 1.14        | 1.14    | ±0.15     |
| b      | 0.40        | 0.40    | ±0.05     |
| c      | 0.14        | 0.14    | ±0.06     |
| D      | 2.90        | 2.90    | Basic     |
| E      | 2.80        | 2.80    | Basic     |
| E1     | 1.60        | 1.60    | Basic     |
| e      | 0.95        | 0.95    | Basic     |
| e1     | 1.90        | 1.90    | Basic     |
| L      | 0.45        | 0.45    | ±0.10     |
| L1     | 0.60        | 0.60    | Reference |
| N      | 5           | 6       | Reference |

Rev. F 2/07

NOTES:

1. Plastic or metal protrusions of 0.25mm maximum per side are not included.
2. Plastic interlead protrusions of 0.25mm maximum per side are not included.
3. This dimension is measured at Datum Plane "H".
4. Dimensioning and tolerancing per ASME Y14.5M-1994.
5. Index area - Pin #1 I.D. will be located within the indicated zone (SOT23-6 only).
6. SOT23-5 version has no center lead (shown as a dashed line).

Small Outline Package Family (SO)

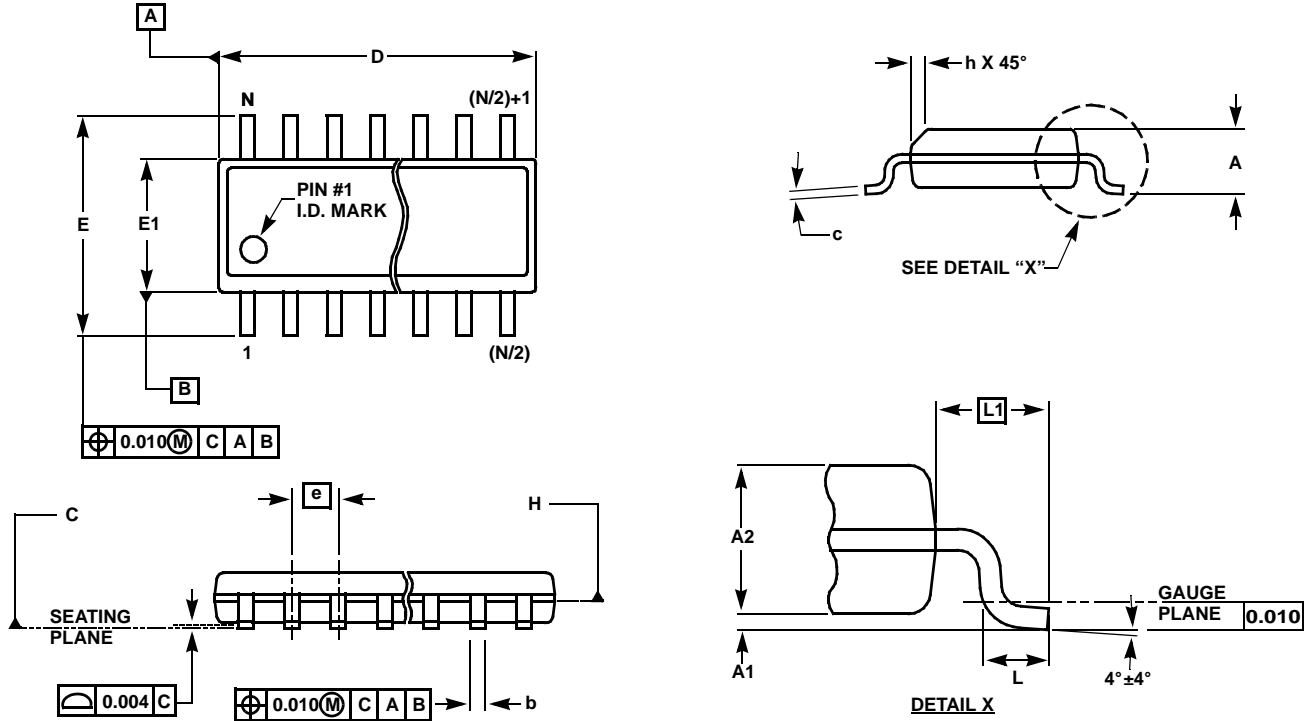

MDP0027

SMALL OUTLINE PACKAGE FAMILY (SO)

| SYMBOL | INCHES |       |               |                        |               |               |               | TOLERANCE   | NOTES |
|--------|--------|-------|---------------|------------------------|---------------|---------------|---------------|-------------|-------|
|        | SO-8   | SO-14 | SO16 (0.150") | SO16 (0.300") (SOL-16) | SO20 (SOL-20) | SO24 (SOL-24) | SO28 (SOL-28) |             |       |
| A      | 0.068  | 0.068 | 0.068         | 0.104                  | 0.104         | 0.104         | 0.104         | MAX         | -     |
| A1     | 0.006  | 0.006 | 0.006         | 0.007                  | 0.007         | 0.007         | 0.007         | $\pm 0.003$ | -     |
| A2     | 0.057  | 0.057 | 0.057         | 0.092                  | 0.092         | 0.092         | 0.092         | $\pm 0.002$ | -     |
| b      | 0.017  | 0.017 | 0.017         | 0.017                  | 0.017         | 0.017         | 0.017         | $\pm 0.003$ | -     |
| c      | 0.009  | 0.009 | 0.009         | 0.011                  | 0.011         | 0.011         | 0.011         | $\pm 0.001$ | -     |
| D      | 0.193  | 0.341 | 0.390         | 0.406                  | 0.504         | 0.606         | 0.704         | $\pm 0.004$ | 1, 3  |
| E      | 0.236  | 0.236 | 0.236         | 0.406                  | 0.406         | 0.406         | 0.406         | $\pm 0.008$ | -     |
| E1     | 0.154  | 0.154 | 0.154         | 0.295                  | 0.295         | 0.295         | 0.295         | $\pm 0.004$ | 2, 3  |
| e      | 0.050  | 0.050 | 0.050         | 0.050                  | 0.050         | 0.050         | 0.050         | Basic       | -     |
| L      | 0.025  | 0.025 | 0.025         | 0.030                  | 0.030         | 0.030         | 0.030         | $\pm 0.009$ | -     |
| L1     | 0.041  | 0.041 | 0.041         | 0.056                  | 0.056         | 0.056         | 0.056         | Basic       | -     |
| h      | 0.013  | 0.013 | 0.013         | 0.020                  | 0.020         | 0.020         | 0.020         | Reference   | -     |
| N      | 8      | 14    | 16            | 16                     | 20            | 24            | 28            | Reference   | -     |

Rev. M 2/07

NOTES:

1. Plastic or metal protrusions of 0.006" maximum per side are not included.
2. Plastic interlead protrusions of 0.010" maximum per side are not included.
3. Dimensions "D" and "E1" are measured at Datum Plane "H".
4. Dimensioning and tolerancing per ASME Y14.5M-1994

Mini SO Package Family (MSOP)

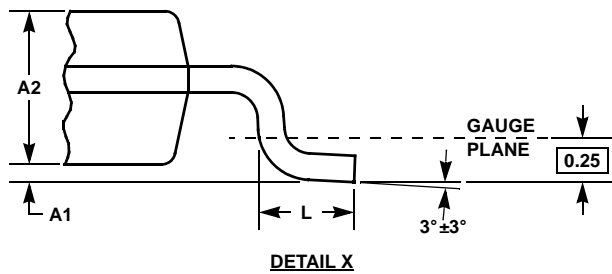
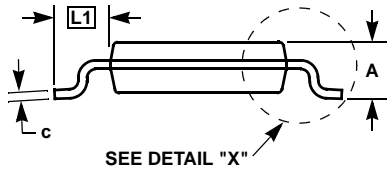
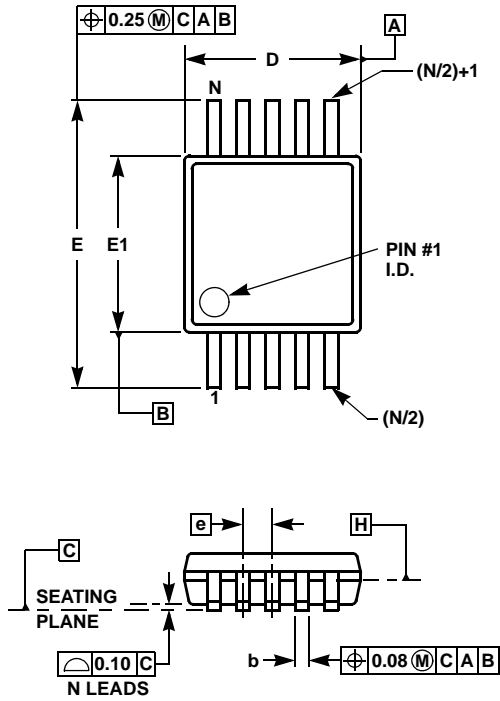

MDP0043  
MINI SO PACKAGE FAMILY

| SYMBOL | MILLIMETERS |        | TOLERANCE   | NOTES |
|--------|-------------|--------|-------------|-------|
|        | MSOP8       | MSOP10 |             |       |
| A      | 1.10        | 1.10   | Max.        | -     |
| A1     | 0.10        | 0.10   | ±0.05       | -     |
| A2     | 0.86        | 0.86   | ±0.09       | -     |
| b      | 0.33        | 0.23   | +0.07/-0.08 | -     |
| c      | 0.18        | 0.18   | ±0.05       | -     |
| D      | 3.00        | 3.00   | ±0.10       | 1, 3  |
| E      | 4.90        | 4.90   | ±0.15       | -     |
| E1     | 3.00        | 3.00   | ±0.10       | 2, 3  |
| e      | 0.65        | 0.50   | Basic       | -     |
| L      | 0.55        | 0.55   | ±0.15       | -     |
| L1     | 0.95        | 0.95   | Basic       | -     |
| N      | 8           | 10     | Reference   | -     |

Rev. D 2/07

NOTES:

1. Plastic or metal protrusions of 0.15mm maximum per side are not included.
2. Plastic interlead protrusions of 0.25mm maximum per side are not included.
3. Dimensions "D" and "E1" are measured at Datum Plane "H".
4. Dimensioning and tolerancing per ASME Y14.5M-1994.

All Intersil U.S. products are manufactured, assembled and tested utilizing ISO9000 quality systems. Intersil Corporation's quality certifications can be viewed at [www.intersil.com/design/quality](http://www.intersil.com/design/quality)

*Intersil products are sold by description only. Intersil Corporation reserves the right to make changes in circuit design, software and/or specifications at any time without notice. Accordingly, the reader is cautioned to verify that data sheets are current before placing orders. Information furnished by Intersil is believed to be accurate and reliable. However, no responsibility is assumed by Intersil or its subsidiaries for its use; nor for any infringements of patents or other rights of third parties which may result from its use. No license is granted by implication or otherwise under any patent or patent rights of Intersil or its subsidiaries.*

For information regarding Intersil Corporation and its products, see [www.intersil.com](http://www.intersil.com)