

TOSHIBA Bipolar Linear Integrated Circuit Silicon Monolithic

TA78L05PF,TA78L06PF,TA78L07PF,TA78L08PF TA78L09PF,TA78L10PF,TA78L12PF,TA78L15PF

5 V, 6 V, 7V, 8 V, 9 V, 10 V, 12 V, 15V

0.15A Positive Voltage Regulators

Housed in a very small and thin PS-8 package, the TA78L**PF series of fixed-voltage monolithic integrated circuit voltage regulators is designed for a wide range of applications. One of these regulators can drive up to 0.15 A of output current. The series offers devices with various output voltages: 5 V, 6 V, 7 V, 8 V, 9 V, 10 V, 12 V, and 15 V.

Features

- Maximum output current: 0.15 A
- Output voltage accuracy: $V_{OUT} \pm 4\%$ ($@T_j = 25^\circ\text{C}$)
- Protection function: Overcurrent/Thermal shutdown
- Package type: PS-8 is a flat lead, 8-pin package.

This is smaller and thinner than the previous PW-Mini(SOT-89), with a 47% decrease in height and a 54% decrease in mounting area.

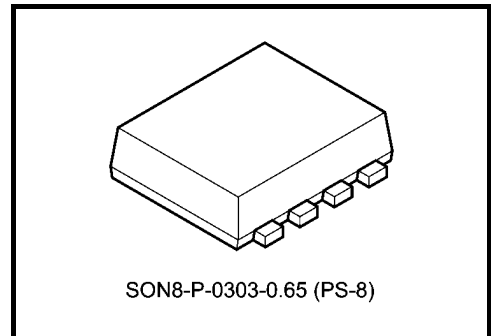

SON8-P-0303-0.65 (PS-8)

Weight: 0.017 g (typ.)

Pin Assignment/Marking

Part No.	Part No. (abbreviation code)
TA78L05PF	78L05
TA78L06PF	78L06
TA78L07PF	78L07
TA78L08PF	78L08
TA78L09PF	78L09
TA78L10PF	78L10
TA78L12PF	78L12
TA78L15PF	78L15

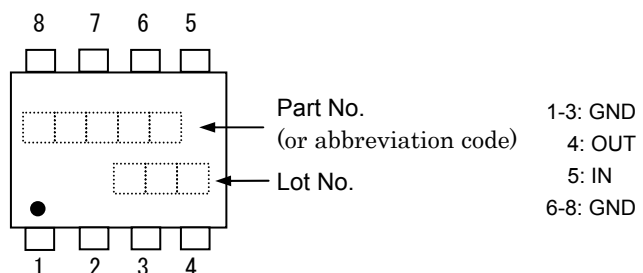

(●) on the lower left of the marking indicates Pin 1.

* Lot No.: The lot no. consists of three digits. The first digit represents the last digit of the year of manufacture, and the following two digits indicates the week of manufacture between 01 and either 52 or 53.

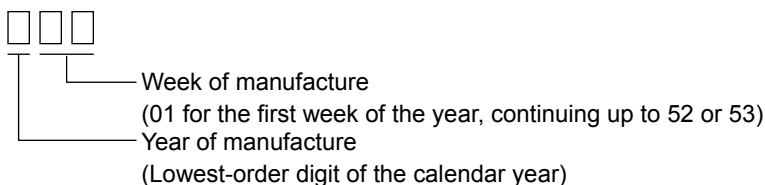

The product(s) in this document ("Product") contain functions intended to protect the Product from temporary small overloads such as minor short-term overcurrent or overheating. The protective functions do not necessarily protect Product under all circumstances. When incorporating Product into your system, please design the system (1) to avoid such overloads upon the Product, and (2) to shut down or otherwise relieve the Product of such overload conditions immediately upon occurrence. For details, please refer to the notes appearing below in this document and other documents referenced in this document.

How to Order

Part No.	Packing Type and Unit for Orders
TA78L**PF (TE85L,F)	Embossed-tape packing: 3000 (1 tape)

Note 1: In the actual product number, " **" is replaced by the output voltage of the product.

Block Diagram

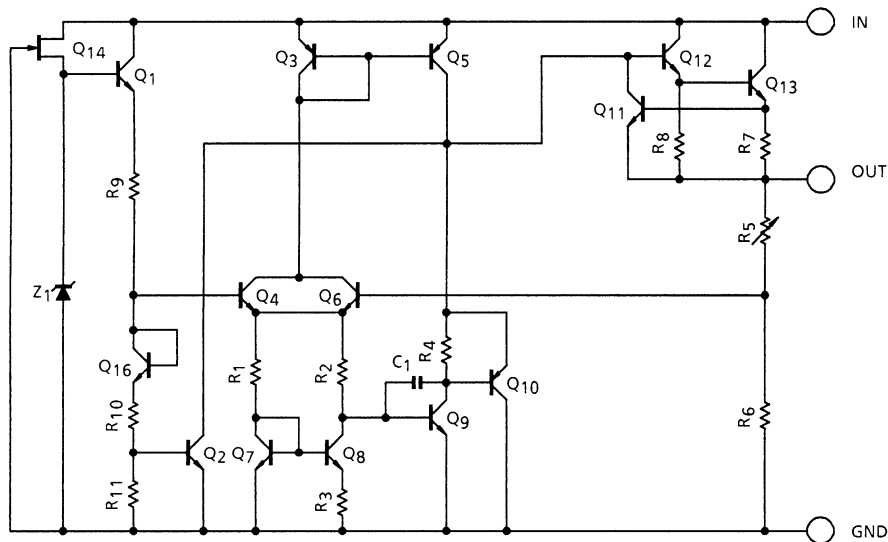

Absolute Maximum Ratings (Ta = 25°C)

Characteristics	Symbol	Rating	Unit
Input voltage	V_{IN}	35	V
Output current	I_{OUT}	0.15	A
Operating temperature	T_{opr}	-30 to 85	°C
Junction temperature	T_j	150	°C
Storage temperature	T_{stg}	-55 to 150	°C
Power dissipation (Note 4a)	P_D	1.3	W
Power dissipation (Note 4b)	P_D	0.62	W

Note 2: Do not apply external current and voltage (including negative voltage) to pins other than those specified.

Note 3: Using continuously under heavy loads (e.g. the application of high temperature/current/voltage and the significant change in temperature, etc.) may cause this product to decrease in the reliability significantly even if the operating conditions (i.e. operating temperature/current/voltage, etc.) are within the absolute maximum ratings and the operating ranges.

Please design the appropriate reliability upon reviewing the Toshiba Semiconductor Reliability Handbook ("Handling Precautions"/"Derating Concept and Methods") and individual reliability data (i.e. reliability test report and estimated failure rate, etc).

Thermal Resistance

Characteristics	Symbol	Rating	Unit
Thermal resistance (junction to ambient) (Note 4a)	$R_{th(j-a)}$	97	°C/W
Thermal resistance (junction to ambient) (Note 4b)	$R_{th(j-a)}$	202	°C/W

Note 4:

(a) Device mounted on a glass-epoxy board

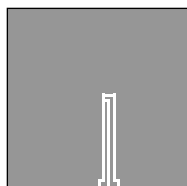

FR-4
 $25.4 \times 25.4 \times 1.6$
 Unit: (mm)
 Cu base thickness
 $35 \mu\text{m}$

(b) Device mounted on a glass-epoxy board

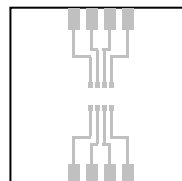

FR-4
 $25.4 \times 25.4 \times 1.6$
 Unit: (mm)
 Cu base thickness
 $35 \mu\text{m}$

TA78L05PF

Electrical Characteristics

($V_{IN} = 10\text{ V}$, $I_{OUT} = 40\text{ mA}$, $C_{IN} = 0.33\text{ }\mu\text{F}$, $C_{OUT} = 0.1\text{ }\mu\text{F}$, $0^\circ\text{C} \leq T_j \leq 125^\circ\text{C}$, unless otherwise specified)

Characteristics	Symbol	Test Circuit	Test Condition	Min	Typ.	Max	Unit	
Output voltage	V_{OUT}	1	$T_j = 25^\circ\text{C}$	4.8	5.0	5.2	V	
Line regulation	Reg-line	1	$T_j = 25^\circ\text{C}$	$7.0\text{ V} \leq V_{IN} \leq 20\text{ V}$	—	55	150	mV
				$8.0\text{ V} \leq V_{IN} \leq 20\text{ V}$	—	45	100	
Load regulation	Reg-load	1	$T_j = 25^\circ\text{C}$	$1.0\text{ mA} \leq I_{OUT} \leq 100\text{ mA}$	—	11	60	mV
				$1.0\text{ mA} \leq I_{OUT} \leq 40\text{ mA}$	—	5.0	30	
Output voltage	V_{OUT}	1	$T_j = 25^\circ\text{C}$	$7.0\text{ V} \leq V_{IN} \leq 20\text{ V}$, $1.0\text{ mA} \leq I_{OUT} \leq 40\text{ mA}$	4.75	—	5.25	V
				$1.0\text{ mA} \leq I_{OUT} \leq 70\text{ mA}$	4.75	—	5.25	
Quiescent current	I_B	1	$T_j = 25^\circ\text{C}$	—	3.1	6.0	mA	
			$T_j = 125^\circ\text{C}$	—	—	5.5		
Quiescent current change	ΔI_B	1	$T_j = 25^\circ\text{C}$	$8.0\text{ V} \leq V_{IN} \leq 20\text{ V}$	—	—	1.5	mA
				$1.0\text{ mA} \leq I_{OUT} \leq 40\text{ mA}$	—	—	0.1	
Output noise voltage	V_{NO}	2	$T_a = 25^\circ\text{C}$, $10\text{ Hz} \leq f \leq 100\text{ kHz}$	—	40	—	μV_{rms}	
Ripple rejection ratio	R.R.	3	$f = 120\text{ Hz}$, $8.0\text{ V} \leq V_{IN} \leq 18\text{ V}$, $T_j = 25^\circ\text{C}$	41	49	—	dB	
Dropout voltage	V_D	1	$T_j = 25^\circ\text{C}$, $I_{OUT} = 150\text{ mA}$	—	2.0	—	V	
Average temperature coefficient of output voltage	T_{CVO}	1	$I_{OUT} = 5\text{ mA}$	—	-0.6	—	$\text{mV}/^\circ\text{C}$	

TA78L06PF

Electrical Characteristics

($V_{IN} = 11\text{ V}$, $I_{OUT} = 40\text{ mA}$, $C_{IN} = 0.33\text{ }\mu\text{F}$, $C_{OUT} = 0.1\text{ }\mu\text{F}$, $0^\circ\text{C} \leq T_j \leq 125^\circ\text{C}$, unless otherwise specified)

Characteristics	Symbol	Test Circuit	Test Condition	Min	Typ.	Max	Unit	
Output voltage	V_{OUT}	1	$T_j = 25^\circ\text{C}$	5.76	6.0	6.24	V	
Line regulation	Reg-line	1	$T_j = 25^\circ\text{C}$	$8.1\text{ V} \leq V_{IN} \leq 21\text{ V}$	—	50	150	mV
				$9.0\text{ V} \leq V_{IN} \leq 21\text{ V}$	—	45	110	
Load regulation	Reg-load	1	$T_j = 25^\circ\text{C}$	$1.0\text{ mA} \leq I_{OUT} \leq 100\text{ mA}$	—	12	70	mV
				$1.0\text{ mA} \leq I_{OUT} \leq 40\text{ mA}$	—	5.5	35	
Output voltage	V_{OUT}	1	$T_j = 25^\circ\text{C}$	$8.1\text{ V} \leq V_{IN} \leq 21\text{ V}$, $1.0\text{ mA} \leq I_{OUT} \leq 40\text{ mA}$	5.7	—	6.3	V
				$1.0\text{ mA} \leq I_{OUT} \leq 70\text{ mA}$	5.7	—	6.3	
Quiescent current	I_B	1	$T_j = 25^\circ\text{C}$	—	3.1	6.0	mA	
			$T_j = 125^\circ\text{C}$	—	—	5.5		
Quiescent current change	ΔI_B	1	$T_j = 25^\circ\text{C}$	$9.0\text{ V} \leq V_{IN} \leq 20\text{ V}$	—	—	1.5	mA
				$1.0\text{ mA} \leq I_{OUT} \leq 40\text{ mA}$	—	—	0.1	
Output noise voltage	V_{NO}	2	$T_a = 25^\circ\text{C}$, $10\text{ Hz} \leq f \leq 100\text{ kHz}$	—	40	—	μV_{rms}	
Ripple rejection ratio	R.R.	3	$f = 120\text{ Hz}$, $9.0\text{ V} \leq V_{IN} \leq 19\text{ V}$, $T_j = 25^\circ\text{C}$	39	47	—	dB	
Dropout voltage	V_D	1	$T_j = 25^\circ\text{C}$, $I_{OUT} = 150\text{ mA}$	—	2.0	—	V	
Average temperature coefficient of output voltage	T_{CVO}	1	$I_{OUT} = 5\text{ mA}$	—	-0.7	—	$\text{mV}/^\circ\text{C}$	

TA78L07PF

Electrical Characteristics

($V_{IN} = 12\text{ V}$, $I_{OUT} = 40\text{ mA}$, $C_{IN} = 0.33\text{ }\mu\text{F}$, $C_{OUT} = 0.1\text{ }\mu\text{F}$, $0^\circ\text{C} \leq T_j \leq 125^\circ\text{C}$, unless otherwise specified)

Characteristics	Symbol	Test Circuit	Test Condition	Min	Typ.	Max	Unit	
Output voltage	V_{OUT}	1	$T_j = 25^\circ\text{C}$	6.72	7.0	7.28	V	
Line regulation	Reg-line	1	$T_j = 25^\circ\text{C}$	$9.2\text{ V} \leq V_{IN} \leq 22\text{ V}$	—	50	160	mV
				$10\text{ V} \leq V_{IN} \leq 22\text{ V}$	—	45	115	
Load regulation	Reg-load	1	$T_j = 25^\circ\text{C}$	$1.0\text{ mA} \leq I_{OUT} \leq 100\text{ mA}$	—	13	75	mV
				$1.0\text{ mA} \leq I_{OUT} \leq 40\text{ mA}$	—	6.0	40	
Output voltage	V_{OUT}	1	$T_j = 25^\circ\text{C}$	$9.2\text{ V} \leq V_{IN} \leq 22\text{ V}$, $1.0\text{ mA} \leq I_{OUT} \leq 40\text{ mA}$	6.65	—	7.35	V
				$1.0\text{ mA} \leq I_{OUT} \leq 70\text{ mA}$	6.65	—	7.35	
Quiescent current	I_B	1	$T_j = 25^\circ\text{C}$	—	3.1	6.5	mA	
			$T_j = 125^\circ\text{C}$	—	—	6.0		
Quiescent current change	ΔI_B	1	$T_j = 25^\circ\text{C}$	$10\text{ V} \leq V_{IN} \leq 22\text{ V}$	—	—	1.5	mA
				$1.0\text{ mA} \leq I_{OUT} \leq 40\text{ mA}$	—	—	0.1	
Output noise voltage	V_{NO}	2	$T_a = 25^\circ\text{C}$, $10\text{ Hz} \leq f \leq 100\text{ kHz}$	—	50	—	μV_{rms}	
Ripple rejection ratio	R.R.	3	$f = 120\text{ Hz}$, $10\text{ V} \leq V_{IN} \leq 20\text{ V}$, $T_j = 25^\circ\text{C}$	37	46	—	dB	
Dropout voltage	V_D	1	$T_j = 25^\circ\text{C}$, $I_{OUT} = 150\text{ mA}$	—	2.0	—	V	
Average temperature coefficient of output voltage	T_{CVO}	1	$I_{OUT} = 5\text{ mA}$	—	-0.75	—	$\text{mV}/^\circ\text{C}$	

TA78L08PF

Electrical Characteristics

($V_{IN} = 14\text{ V}$, $I_{OUT} = 40\text{ mA}$, $C_{IN} = 0.33\text{ }\mu\text{F}$, $C_{OUT} = 0.1\text{ }\mu\text{F}$, $0^\circ\text{C} \leq T_j \leq 125^\circ\text{C}$, unless otherwise specified)

Characteristics	Symbol	Test Circuit	Test Condition	Min	Typ.	Max	Unit	
Output voltage	V_{OUT}	1	$T_j = 25^\circ\text{C}$	7.68	8.0	8.32	V	
Line regulation	Reg-line	1	$T_j = 25^\circ\text{C}$	$10.5\text{ V} \leq V_{IN} \leq 23\text{ V}$	—	20	175	mV
				$11\text{ V} \leq V_{IN} \leq 23\text{ V}$	—	12	125	
Load regulation	Reg-load	1	$T_j = 25^\circ\text{C}$	$1.0\text{ mA} \leq I_{OUT} \leq 100\text{ mA}$	—	15	80	mV
				$1.0\text{ mA} \leq I_{OUT} \leq 40\text{ mA}$	—	7.0	40	
Output voltage	V_{OUT}	1	$T_j = 25^\circ\text{C}$	$10.5\text{ V} \leq V_{IN} \leq 23\text{ V}$, $1.0\text{ mA} \leq I_{OUT} \leq 40\text{ mA}$	7.6	—	8.4	V
				$1.0\text{ mA} \leq I_{OUT} \leq 70\text{ mA}$	7.6	—	8.4	
Quiescent current	I_B	1	$T_j = 25^\circ\text{C}$	—	3.1	6.5	mA	
			$T_j = 125^\circ\text{C}$	—	—	6.0		
Quiescent current change	ΔI_B	1	$T_j = 25^\circ\text{C}$	$11\text{ V} \leq V_{IN} \leq 23\text{ V}$	—	—	1.5	mA
				$1.0\text{ mA} \leq I_{OUT} \leq 40\text{ mA}$	—	—	0.1	
Output noise voltage	V_{NO}	2	$T_a = 25^\circ\text{C}$, $10\text{ Hz} \leq f \leq 100\text{ kHz}$	—	60	—	μV_{rms}	
Ripple rejection ratio	R.R.	3	$f = 120\text{ Hz}$, $12\text{ V} \leq V_{IN} \leq 23\text{ V}$, $T_j = 25^\circ\text{C}$	37	45	—	dB	
Dropout voltage	V_D	1	$T_j = 25^\circ\text{C}$, $I_{OUT} = 150\text{ mA}$	—	2.0	—	V	
Average temperature coefficient of output voltage	T_{CVO}	1	$I_{OUT} = 5\text{ mA}$	—	-0.8	—	$\text{mV}/^\circ\text{C}$	

TA78L09PF

Electrical Characteristics

($V_{IN} = 15\text{ V}$, $I_{OUT} = 40\text{ mA}$, $C_{IN} = 0.33\text{ }\mu\text{F}$, $C_{OUT} = 0.1\text{ }\mu\text{F}$, $0^\circ\text{C} \leq T_j \leq 125^\circ\text{C}$, unless otherwise specified)

Characteristics	Symbol	Test Circuit	Test Condition	Min	Typ.	Max	Unit	
Output voltage	V_{OUT}	1	$T_j = 25^\circ\text{C}$	8.64	9.0	9.36	V	
Line regulation	Reg-line	1	$T_j = 25^\circ\text{C}$	$11.4\text{ V} \leq V_{IN} \leq 24\text{ V}$	—	80	200	mV
				$12\text{ V} \leq V_{IN} \leq 24\text{ V}$	—	20	160	
Load regulation	Reg-load	1	$T_j = 25^\circ\text{C}$	$1.0\text{ mA} \leq I_{OUT} \leq 100\text{ mA}$	—	17	90	mV
				$1.0\text{ mA} \leq I_{OUT} \leq 40\text{ mA}$	—	8.0	45	
Output voltage	V_{OUT}	1	$T_j = 25^\circ\text{C}$	$11.4\text{ V} \leq V_{IN} \leq 24\text{ V}$, $1.0\text{ mA} \leq I_{OUT} \leq 40\text{ mA}$	8.55	—	9.45	V
				$1.0\text{ mA} \leq I_{OUT} \leq 70\text{ mA}$	8.55	—	9.45	
Quiescent current	I_B	1	$T_j = 25^\circ\text{C}$	—	3.2	6.5	mA	
			$T_j = 125^\circ\text{C}$	—	—	6.0		
Quiescent current change	ΔI_B	1	$T_j = 25^\circ\text{C}$	$12\text{ V} \leq V_{IN} \leq 24\text{ V}$	—	—	1.5	mA
				$1.0\text{ mA} \leq I_{OUT} \leq 40\text{ mA}$	—	—	0.1	
Output noise voltage	V_{NO}	2	$T_a = 25^\circ\text{C}$, $10\text{ Hz} \leq f \leq 100\text{ kHz}$	—	65	—	μV_{rms}	
Ripple rejection ratio	R.R.	3	$f = 120\text{ Hz}$, $12\text{ V} \leq V_{IN} \leq 24\text{ V}$, $T_j = 25^\circ\text{C}$	36	44	—	dB	
Dropout voltage	V_D	1	$T_j = 25^\circ\text{C}$, $I_{OUT} = 150\text{ mA}$	—	2.0	—	V	
Average temperature coefficient of output voltage	T_{CVO}	1	$I_{OUT} = 5\text{ mA}$	—	-0.85	—	$\text{mV}/^\circ\text{C}$	

TA78L10PF

Electrical Characteristics

($V_{IN} = 16\text{ V}$, $I_{OUT} = 40\text{ mA}$, $C_{IN} = 0.33\text{ }\mu\text{F}$, $C_{OUT} = 0.1\text{ }\mu\text{F}$, $0^\circ\text{C} \leq T_j \leq 125^\circ\text{C}$, unless otherwise specified)

Characteristics	Symbol	Test Circuit	Test Condition	Min	Typ.	Max	Unit	
Output voltage	V_{OUT}	1	$T_j = 25^\circ\text{C}$	9.6	10	10.4	V	
Line regulation	Reg-line	1	$T_j = 25^\circ\text{C}$	$12.5\text{ V} \leq V_{IN} \leq 25\text{ V}$	—	80	230	mV
				$13\text{ V} \leq V_{IN} \leq 25\text{ V}$	—	30	170	
Load regulation	Reg-load	1	$T_j = 25^\circ\text{C}$	$1.0\text{ mA} \leq I_{OUT} \leq 100\text{ mA}$	—	18	90	mV
				$1.0\text{ mA} \leq I_{OUT} \leq 40\text{ mA}$	—	8.5	45	
Output voltage	V_{OUT}	1	$T_j = 25^\circ\text{C}$	$12.5\text{ V} \leq V_{IN} \leq 25\text{ V}$, $1.0\text{ mA} \leq I_{OUT} \leq 40\text{ mA}$	9.5	—	10.5	V
				$1.0\text{ mA} \leq I_{OUT} \leq 70\text{ mA}$	9.5	—	10.5	
Quiescent current	I_B	1	$T_j = 25^\circ\text{C}$	—	3.2	6.5	mA	
			$T_j = 125^\circ\text{C}$	—	—	6.0		
Quiescent current change	ΔI_B	1	$T_j = 25^\circ\text{C}$	$13\text{ V} \leq V_{IN} \leq 25\text{ V}$	—	—	1.5	mA
				$1.0\text{ mA} \leq I_{OUT} \leq 40\text{ mA}$	—	—	0.1	
Output noise voltage	V_{NO}	2	$T_a = 25^\circ\text{C}$, $10\text{ Hz} \leq f \leq 100\text{ kHz}$	—	70	—	μV_{rms}	
Ripple rejection ratio	R.R.	3	$f = 120\text{ Hz}$, $13\text{ V} \leq V_{IN} \leq 24\text{ V}$, $T_j = 25^\circ\text{C}$	36	43	—	dB	
Dropout voltage	V_D	1	$T_j = 25^\circ\text{C}$, $I_{OUT} = 150\text{ mA}$	—	2.0	—	V	
Average temperature coefficient of output voltage	T_{CVO}	1	$I_{OUT} = 5\text{ mA}$	—	-0.9	—	$\text{mV}/^\circ\text{C}$	

TA78L12PF

Electrical Characteristics

($V_{IN} = 19\text{ V}$, $I_{OUT} = 40\text{ mA}$, $C_{IN} = 0.33\text{ }\mu\text{F}$, $C_{OUT} = 0.1\text{ }\mu\text{F}$, $0^\circ\text{C} \leq T_j \leq 125^\circ\text{C}$, unless otherwise specified)

Characteristics	Symbol	Test Circuit	Test Condition	Min	Typ.	Max	Unit	
Output voltage	V_{OUT}	1	$T_j = 25^\circ\text{C}$	11.52	12	12.48	V	
Line regulation	Reg-line	1	$T_j = 25^\circ\text{C}$	$14.5\text{ V} \leq V_{IN} \leq 27\text{ V}$	—	120	250	mV
				$16\text{ V} \leq V_{IN} \leq 27\text{ V}$	—	100	200	
Load regulation	Reg-load	1	$T_j = 25^\circ\text{C}$	$1.0\text{ mA} \leq I_{OUT} \leq 100\text{ mA}$	—	20	100	mV
				$1.0\text{ mA} \leq I_{OUT} \leq 40\text{ mA}$	—	10	50	
Output voltage	V_{OUT}	1	$T_j = 25^\circ\text{C}$	$14.5\text{ V} \leq V_{IN} \leq 27\text{ V}$, $1.0\text{ mA} \leq I_{OUT} \leq 40\text{ mA}$	11.4	—	12.6	V
				$1.0\text{ mA} \leq I_{OUT} \leq 70\text{ mA}$	11.4	—	12.6	
Quiescent current	I_B	1	$T_j = 25^\circ\text{C}$	—	3.2	6.5	mA	
			$T_j = 125^\circ\text{C}$	—	—	6.0		
Quiescent current change	ΔI_B	1	$T_j = 25^\circ\text{C}$	$16\text{ V} \leq V_{IN} \leq 27\text{ V}$	—	—	1.5	mA
				$1.0\text{ mA} \leq I_{OUT} \leq 40\text{ mA}$	—	—	0.1	
Output noise voltage	V_{NO}	2	$T_a = 25^\circ\text{C}$, $10\text{ Hz} \leq f \leq 100\text{ kHz}$	—	80	—	μV_{rms}	
Ripple rejection ratio	R.R.	3	$f = 120\text{ Hz}$, $15\text{ V} \leq V_{IN} \leq 25\text{ V}$, $T_j = 25^\circ\text{C}$	36	41	—	dB	
Dropout voltage	V_D	1	$T_j = 25^\circ\text{C}$, $I_{OUT} = 150\text{ mA}$	—	2.0	—	V	
Average temperature coefficient of output voltage	T_{CVO}	1	$I_{OUT} = 5\text{ mA}$	—	-1.0	—	$\text{mV}/^\circ\text{C}$	

TA78L15PF

Electrical Characteristics

($V_{IN} = 23\text{ V}$, $I_{OUT} = 40\text{ mA}$, $C_{IN} = 0.33\text{ }\mu\text{F}$, $C_{OUT} = 0.1\text{ }\mu\text{F}$, $0^\circ\text{C} \leq T_j \leq 125^\circ\text{C}$, unless otherwise specified)

Characteristics	Symbol	Test Circuit	Test Condition	Min	Typ.	Max	Unit	
Output voltage	V_{OUT}	1	$T_j = 25^\circ\text{C}$	14.4	15	15.6	V	
Line regulation	Reg-line	1	$T_j = 25^\circ\text{C}$	$17.5\text{ V} \leq V_{IN} \leq 30\text{ V}$	—	130	300	mV
				$20\text{ V} \leq V_{IN} \leq 30\text{ V}$	—	110	250	
Load regulation	Reg-load	1	$T_j = 25^\circ\text{C}$	$1.0\text{ mA} \leq I_{OUT} \leq 100\text{ mA}$	—	25	150	mV
				$1.0\text{ mA} \leq I_{OUT} \leq 40\text{ mA}$	—	12	75	
Output voltage	V_{OUT}	1	$T_j = 25^\circ\text{C}$	$17.5\text{ V} \leq V_{IN} \leq 30\text{ V}$, $1.0\text{ mA} \leq I_{OUT} \leq 40\text{ mA}$	14.25	—	15.75	V
				$1.0\text{ mA} \leq I_{OUT} \leq 70\text{ mA}$	14.25	—	15.75	
Quiescent current	I_B	1	$T_j = 25^\circ\text{C}$	—	3.3	6.5	mA	
			$T_j = 125^\circ\text{C}$	—	—	6.0		
Quiescent current change	ΔI_B	1	$T_j = 25^\circ\text{C}$	$20\text{ V} \leq V_{IN} \leq 30\text{ V}$	—	—	1.5	mA
				$1.0\text{ mA} \leq I_{OUT} \leq 40\text{ mA}$	—	—	0.1	
Output noise voltage	V_{NO}	2	$T_a = 25^\circ\text{C}$, $10\text{ Hz} \leq f \leq 100\text{ kHz}$	—	90	—	μV_{rms}	
Ripple rejection ratio	R.R.	3	$f = 120\text{ Hz}$, $18.5\text{ V} \leq V_{IN} \leq 28.5\text{ V}$, $T_j = 25^\circ\text{C}$	34	40	—	dB	
Dropout voltage	V_D	1	$T_j = 25^\circ\text{C}$, $I_{OUT} = 150\text{ mA}$	—	2.0	—	V	
Average temperature coefficient of output voltage	T_{CVO}	1	$I_{OUT} = 5\text{ mA}$	—	-1.3	—	$\text{mV}/^\circ\text{C}$	

Electrical Characteristics for All Products

Generally, the characteristics of power supply ICs change according to temperature fluctuations. The specification $T_j = 25^\circ\text{C}$ is based on a state where temperature increase has no effect (assuming no fluctuation in the characteristics) as ascertained by pulse tests.

Test Circuit 1/Standard Application Example

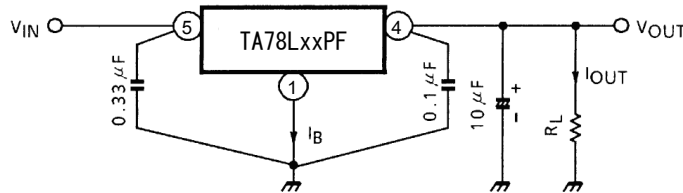

Use capacitors to connect the input terminal and GND and the output terminal and GND. The capacitances should be determined experimentally. In particular, adequate investigation should be made to ensure there is no problem even in high or low temperatures.

Test Circuit 2

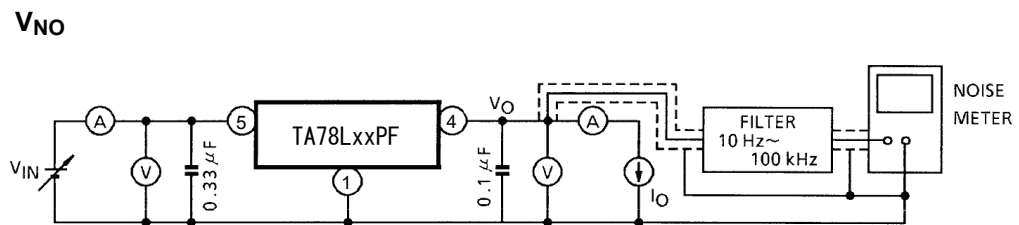

Test Circuit 3

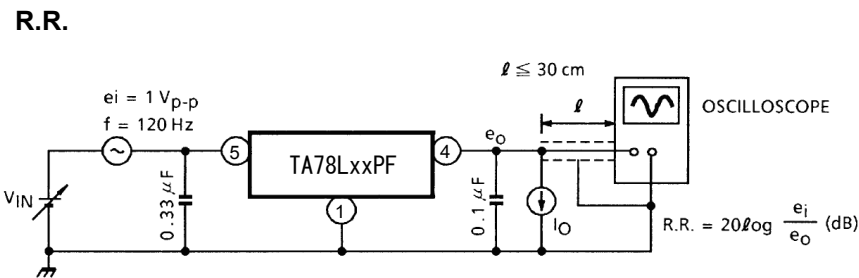

Usage Precautions

- If a high voltage in excess of the output voltage (typ. value) of the IC is applied to the output terminal of the IC, the IC may be destroyed. To prevent such application of excessive voltage, connect a Zener diode between the output terminal and GND.

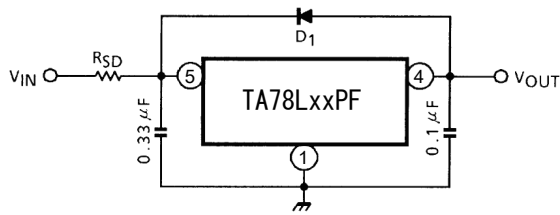

D₁ : IC protective diode

When surge voltage is applied to IC output terminal or $V_{IN} < V_{OUT}$ at the time of power ON/OFF, always connect the high speed swithing diode D₁.

R_{SD} : Power limiting resistor

If V_{IN} is too high, always connect R_{SD} in order to reduce power consumption of IC.

- Low voltage

Do not apply voltage to the Product that is lower than the minimum operating voltage, or the Product's protective functions will not operate properly and the Product may be permanently damaged.

- Overcurrent Protection

The overcurrent protection circuits in the Product are designed to temporarily protect Product from minor overcurrent of brief duration. When the overcurrent protective function in the Product activates, immediately cease application of overcurrent to Product. Improper usage of Product, such as application of current to Product exceeding the absolute maximum ratings, could cause the overcurrent protection circuit not to operate properly and/or damage Product permanently even before the protection circuit starts to operate.

- Thermal shutdown Protection

The thermal shutdown circuits in the Product are designed to temporarily protect Product from minor overheating of brief duration. When the thermal shutdown protective function in the Product activates, immediately correct the overheating situation. Improper usage of Product, such as the application of heat to Product exceeding the absolute maximum ratings, could cause the thermal shutdown protection circuit not to operate properly and/or damage Product permanently even before the protection circuit starts to operate.

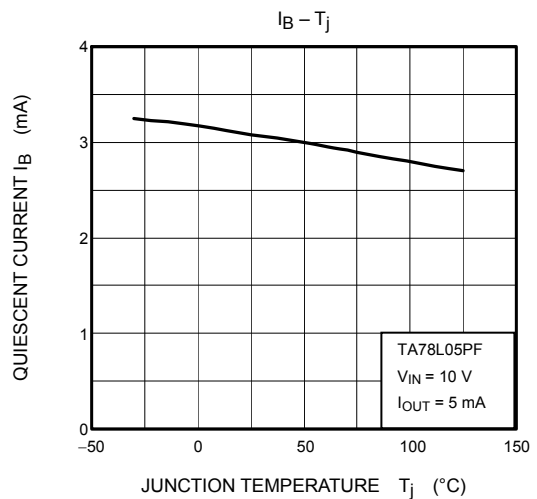
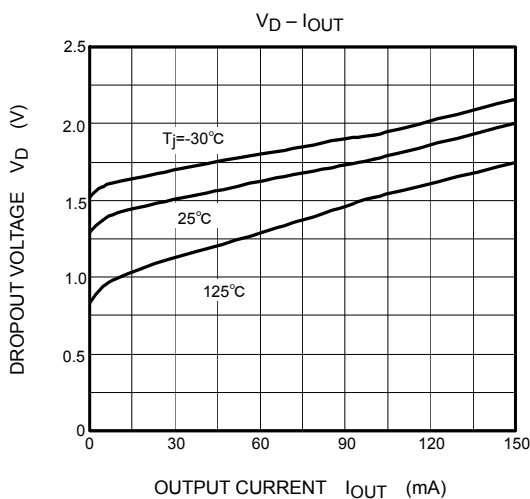
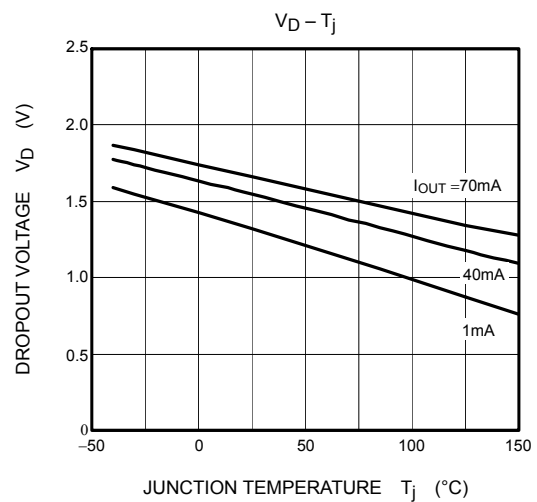
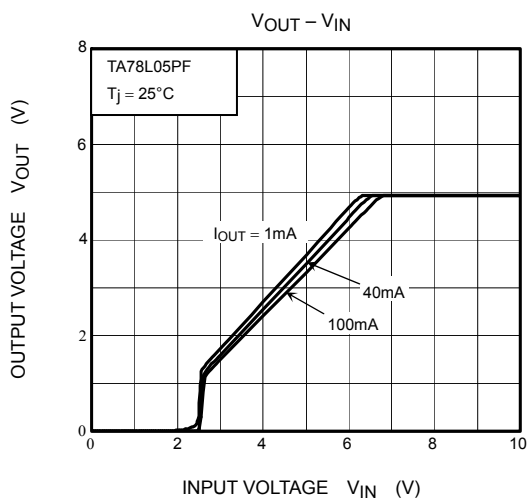
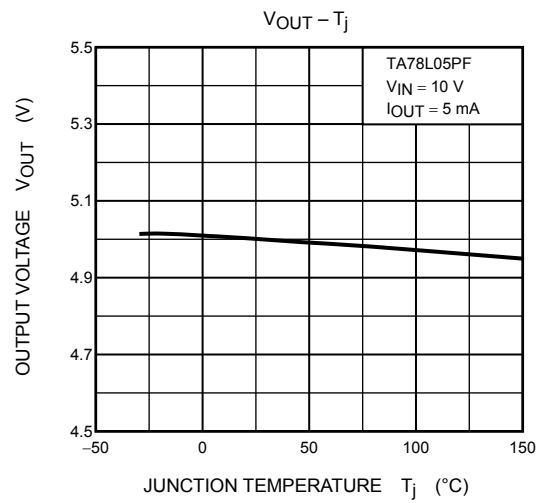
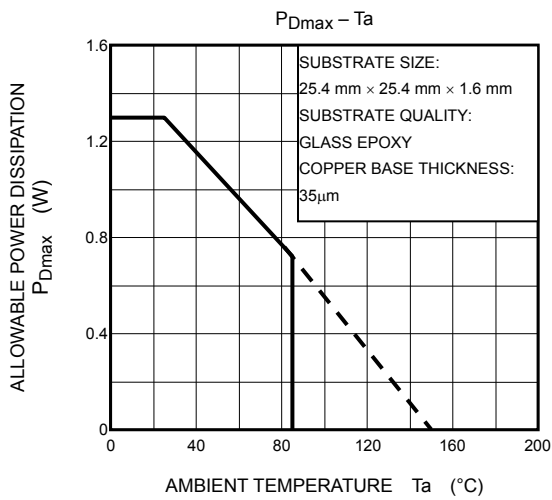

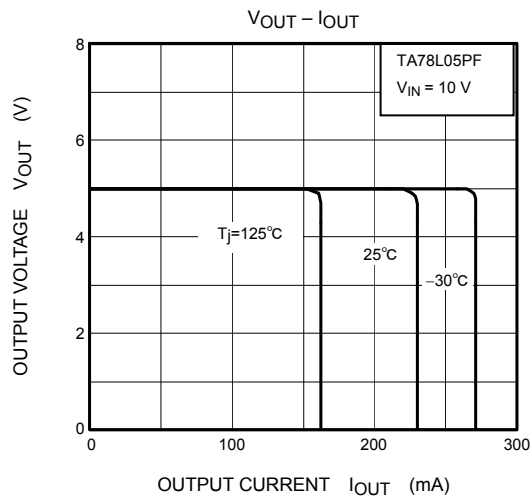
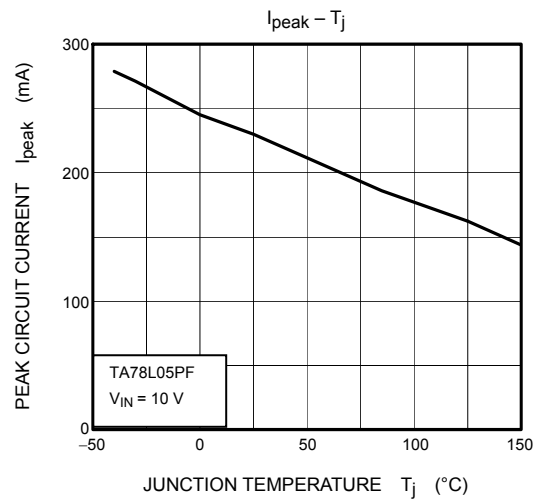
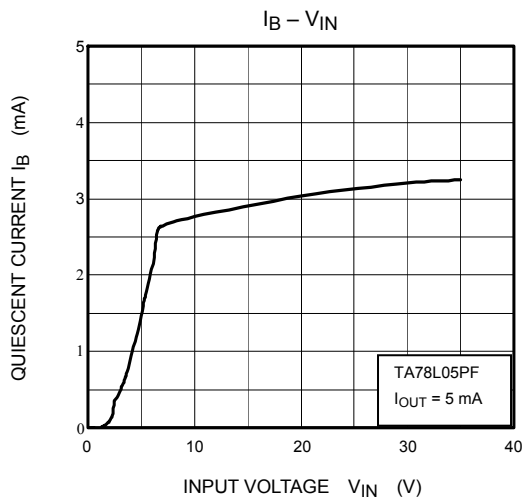

Package Dimensions

SON8-P-0303-0.65 (PS-8)

Unit: mm

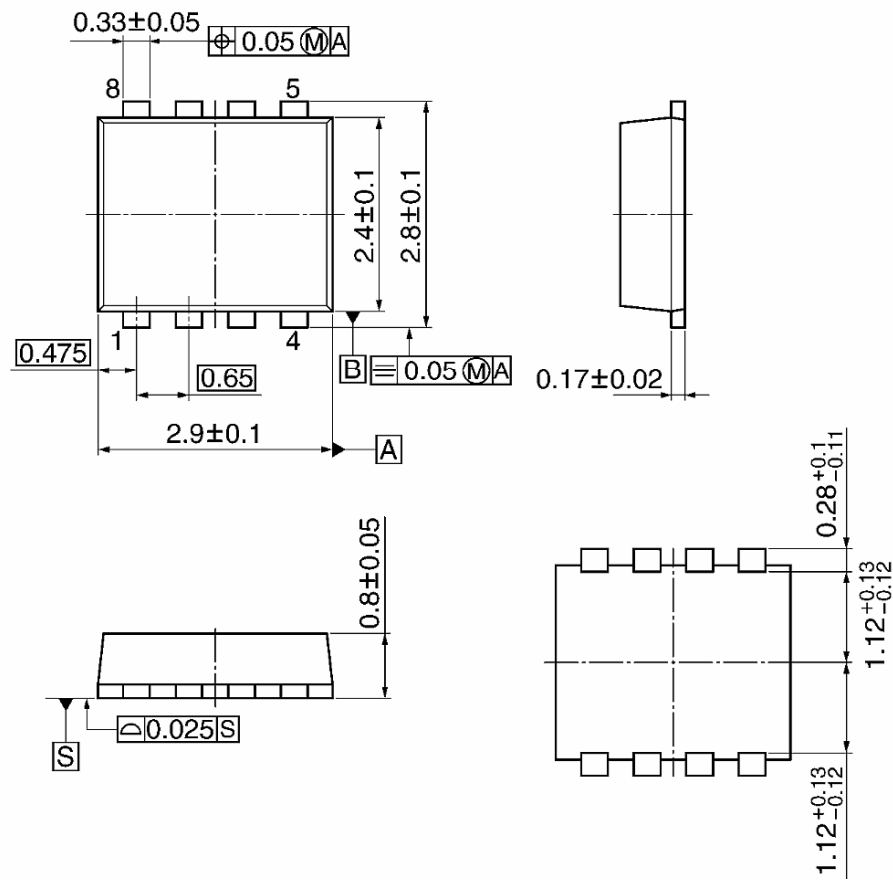

Weight: 0.017 g (typ.)

RESTRICTIONS ON PRODUCT USE

- Toshiba Corporation, and its subsidiaries and affiliates (collectively "TOSHIBA"), reserve the right to make changes to the information in this document, and related hardware, software and systems (collectively "Product") without notice.
- This document and any information herein may not be reproduced without prior written permission from TOSHIBA. Even with TOSHIBA's written permission, reproduction is permissible only if reproduction is without alteration/omission.
- Though TOSHIBA works continually to improve Product's quality and reliability, Product can malfunction or fail. Customers are responsible for complying with safety standards and for providing adequate designs and safeguards for their hardware, software and systems which minimize risk and avoid situations in which a malfunction or failure of Product could cause loss of human life, bodily injury or damage to property, including data loss or corruption. Before customers use the Product, create designs including the Product, or incorporate the Product into their own applications, customers must also refer to and comply with (a) the latest versions of all relevant TOSHIBA information, including without limitation, this document, the specifications, the data sheets and application notes for Product and the precautions and conditions set forth in the "TOSHIBA Semiconductor Reliability Handbook" and (b) the instructions for the application with which the Product will be used with or for. Customers are solely responsible for all aspects of their own product design or applications, including but not limited to (a) determining the appropriateness of the use of this Product in such design or applications; (b) evaluating and determining the applicability of any information contained in this document, or in charts, diagrams, programs, algorithms, sample application circuits, or any other referenced documents; and (c) validating all operating parameters for such designs and applications. **TOSHIBA ASSUMES NO LIABILITY FOR CUSTOMERS' PRODUCT DESIGN OR APPLICATIONS.**
- Product is intended for use in general electronics applications (e.g., computers, personal equipment, office equipment, measuring equipment, industrial robots and home electronics appliances) or for specific applications as expressly stated in this document. Product is neither intended nor warranted for use in equipment or systems that require extraordinarily high levels of quality and/or reliability and/or a malfunction or failure of which may cause loss of human life, bodily injury, serious property damage or serious public impact ("Unintended Use"). Unintended Use includes, without limitation, equipment used in nuclear facilities, equipment used in the aerospace industry, medical equipment, equipment used for automobiles, trains, ships and other transportation, traffic signaling equipment, equipment used to control combustions or explosions, safety devices, elevators and escalators, devices related to electric power, and equipment used in finance-related fields. Do not use Product for Unintended Use unless specifically permitted in this document.
- Do not disassemble, analyze, reverse-engineer, alter, modify, translate or copy Product, whether in whole or in part.
- Product shall not be used for or incorporated into any products or systems whose manufacture, use, or sale is prohibited under any applicable laws or regulations.
- The information contained herein is presented only as guidance for Product use. No responsibility is assumed by TOSHIBA for any infringement of patents or any other intellectual property rights of third parties that may result from the use of Product. No license to any intellectual property right is granted by this document, whether express or implied, by estoppel or otherwise.
- **ABSENT A WRITTEN SIGNED AGREEMENT, EXCEPT AS PROVIDED IN THE RELEVANT TERMS AND CONDITIONS OF SALE FOR PRODUCT, AND TO THE MAXIMUM EXTENT ALLOWABLE BY LAW, TOSHIBA (1) ASSUMES NO LIABILITY WHATSOEVER, INCLUDING WITHOUT LIMITATION, INDIRECT, CONSEQUENTIAL, SPECIAL, OR INCIDENTAL DAMAGES OR LOSS, INCLUDING WITHOUT LIMITATION, LOSS OF PROFITS, LOSS OF OPPORTUNITIES, BUSINESS INTERRUPTION AND LOSS OF DATA, AND (2) DISCLAIMS ANY AND ALL EXPRESS OR IMPLIED WARRANTIES AND CONDITIONS RELATED TO SALE, USE OF PRODUCT, OR INFORMATION, INCLUDING WARRANTIES OR CONDITIONS OF MERCHANTABILITY, FITNESS FOR A PARTICULAR PURPOSE, ACCURACY OF INFORMATION, OR NONINFRINGEMENT.**
- Do not use or otherwise make available Product or related software or technology for any military purposes, including without limitation, for the design, development, use, stockpiling or manufacturing of nuclear, chemical, or biological weapons or missile technology products (mass destruction weapons). Product and related software and technology may be controlled under the Japanese Foreign Exchange and Foreign Trade Law and the U.S. Export Administration Regulations. Export and re-export of Product or related software or technology are strictly prohibited except in compliance with all applicable export laws and regulations.
- Please contact your TOSHIBA sales representative for details as to environmental matters such as the RoHS compatibility of Product. Please use Product in compliance with all applicable laws and regulations that regulate the inclusion or use of controlled substances, including without limitation, the EU RoHS Directive. TOSHIBA assumes no liability for damages or losses occurring as a result of noncompliance with applicable laws and regulations.