

TOSHIBA CMOS Digital Integrated Circuit Silicon Monolithic

TC74LCX16374FT

Low-Voltage 16-Bit D-Type Flip-Flop with 5-V Tolerant Inputs and Outputs

The TC74LCX16374FT is a high-performance CMOS 16-bit D-type flip-flop. Designed for use in 2.5-V or 3.3-V systems, it achieves high-speed operation while maintaining the CMOS low power dissipation.

The device is designed for low-voltage (2.5-V or 3.3-V) VCC applications, but it could be used to interface to 5-V supply environment for both inputs and outputs.

This 16-bit D-type flip-flop is controlled by a clock input (CK) and an output enable input (\overline{OE}) which are common to each byte. It can be used as two 8-bit flip-flops or one 16-bit flip-flop. When the \overline{OE} input is high, the outputs are in a high-impedance state.

All inputs are equipped with protection circuits against static discharge.

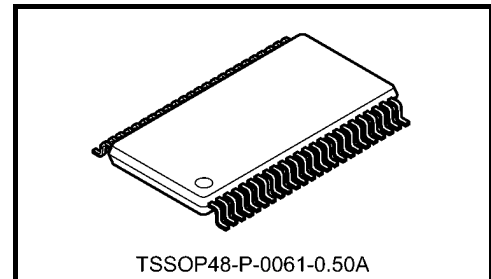

Weight: 0.25 g (typ.)

Features

- Low-voltage operation: $V_{CC} = 2.0$ to 3.6 V
- High-speed operation: $t_{pd} = 6.2$ ns (max) ($V_{CC} = 3.0$ to 3.6 V)
- Output current: $|I_{OH}|/I_{OL} = 24$ mA (min) ($V_{CC} = 3.0$ V)
- Latch-up performance: -500 mA
- Package: TSSOP
- Power-down protection provided on all inputs and outputs

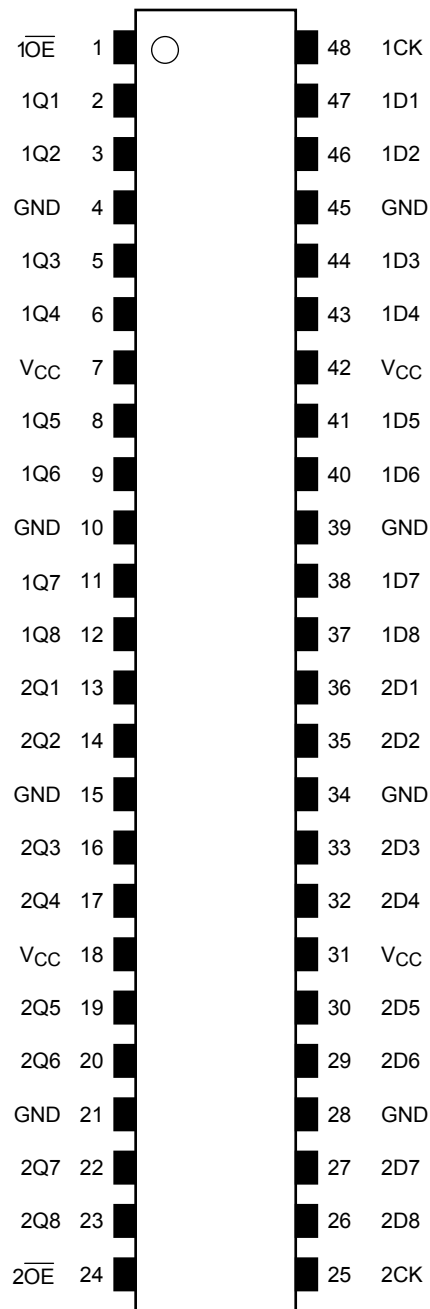

Pin Assignment (top view)



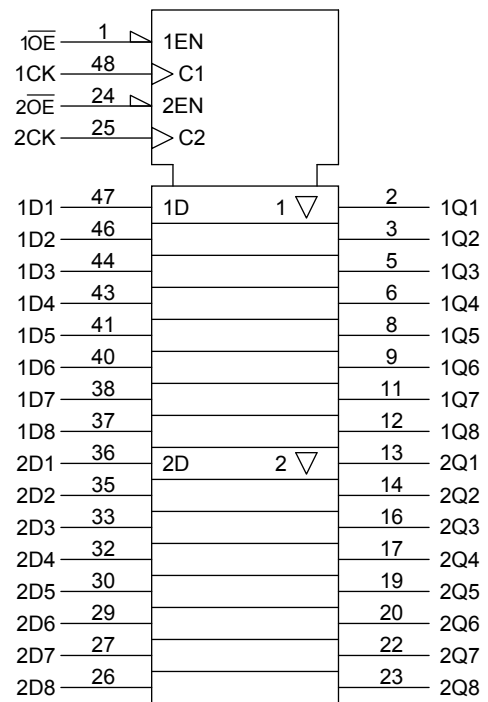

IEC Logic Symbol



Truth Table

Inputs			Outputs
$\overline{1OE}$	1CK	1D1-1D8	1Q1-1Q8
H	X	X	Z
L		X	Qn
L		L	L
L		H	H

Inputs			Outputs
$\overline{2OE}$	2CK	2D1-2D8	2Q1-2Q8
H	X	X	Z
L		X	Qn
L		L	L
L		H	H

X: Don't care

Z: High impedance

Qn: No change

System Diagram

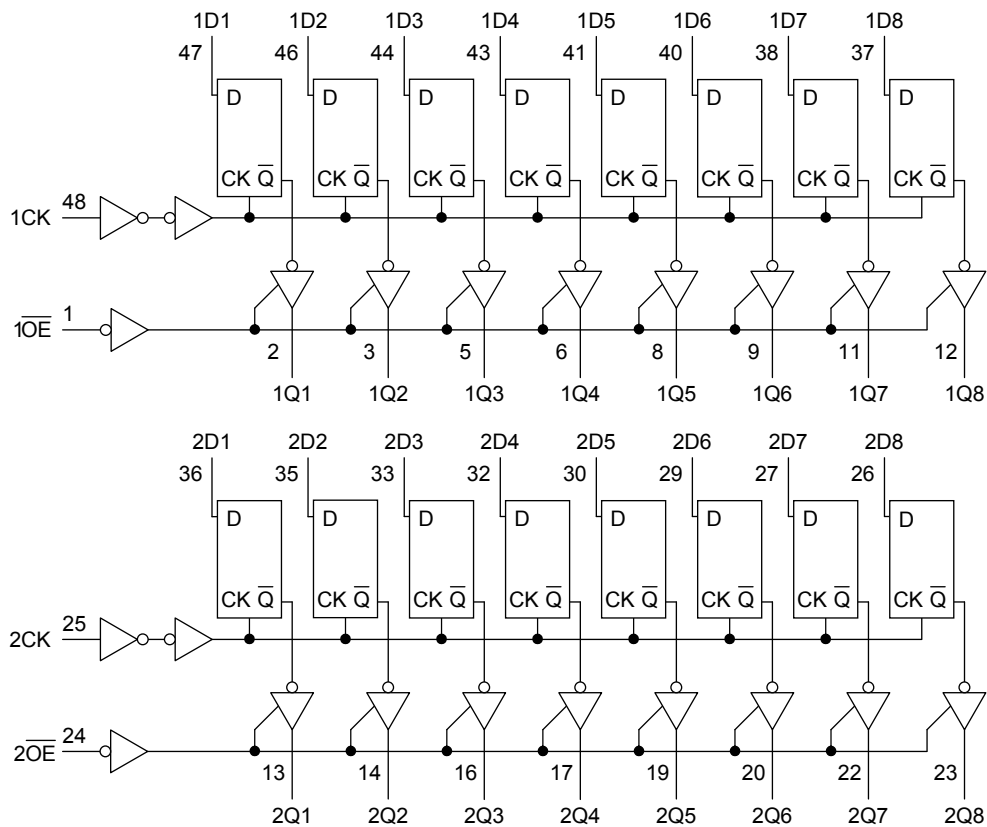

Absolute Maximum Ratings (Note 1)

Characteristics	Symbol	Rating	Unit
Power supply voltage	V_{CC}	-0.5 to 6.0	V
Input voltage	V_{IN}	-0.5 to 7.0	V
Output voltage	V_{OUT}	-0.5 to 7.0 (Note 2)	V
		-0.5 to $V_{CC} + 0.5$ (Note 3)	
Input diode current	I_{IK}	-50	mA
Output diode current	I_{OK}	±50 (Note 4)	mA
DC output current	I_{OUT}	±50	mA
Power dissipation	P_D	400	mW
DC V_{CC} /ground current per supply pin	I_{CC}/I_{GND}	±100	mA
Storage temperature	T_{stg}	-65 to 150	°C

Note 1: Exceeding any of the absolute maximum ratings, even briefly, lead to deterioration in IC performance or even destruction.

Using continuously under heavy loads (e.g. the application of high temperature/current/voltage and the significant change in temperature, etc.) may cause this product to decrease in the reliability significantly even if the operating conditions (i.e. operating temperature/current/voltage, etc.) are within the absolute maximum ratings and the operating ranges.

Please design the appropriate reliability upon reviewing the Toshiba Semiconductor Reliability Handbook ("Handling Precautions"/"Derating Concept and Methods") and individual reliability data (i.e. reliability test report and estimated failure rate, etc).

Note 2: Output in OFF state

Note 3: High or low state. I_{OUT} absolute maximum rating must be observed.

Note 4: $V_{OUT} < GND$, $V_{OUT} > V_{CC}$

Operating Ranges (Note 1)

Characteristics	Symbol	Rating	Unit
Power supply voltage	V_{CC}	2.0 to 3.6	V
		1.5 to 3.6 (Note 2)	
Input voltage	V_{IN}	0 to 5.5	V
Output voltage	V_{OUT}	0 to 5.5 (Note 3)	V
		0 to V_{CC} (Note 4)	
Output current	I_{OH}/I_{OL}	±24 (Note 5)	mA
		±12 (Note 6)	
		±8 (Note 7)	
Operating temperature	T_{opr}	-40 to 85	°C
Input rise and fall time	dt/dv	0 to 10 (Note 8)	ns/V

Note 1: The operating ranges must be maintained to ensure the normal operation of the device. Unused inputs must be tied to either V_{CC} or GND.

Note 2: Data retention only

Note 3: Output in OFF state

Note 4: High or low state

Note 5: $V_{CC} = 3.0$ to 3.6 V

Note 6: $V_{CC} = 2.7$ to 3.0 V

Note 7: $V_{CC} = 2.3$ to 2.7 V

Note 8: $V_{IN} = 0.8$ to 2.0 V, $V_{CC} = 3.0$ V

Electrical Characteristics

DC Characteristics (Ta = -40 to 85°C)

Characteristics		Symbol	Test Condition		V _{CC} (V)	Min	Max	Unit	
Input voltage	H-level	V _{IH}	—		2.3 to 2.7	1.7	—	V	
					2.7 to 3.6	2.0	—		
	L-level	V _{IL}			2.3 to 2.7	—	0.7		
					2.7 to 3.6	—	0.8		
Output voltage	H-level	V _{OH}	V _{IN} = V _{IH} or V _{IL}		I _{OH} = -100 μA	2.3 to 3.6	V _{CC} - 0.2	—	V
					I _{OH} = -8 mA	2.3	1.8	—	
					I _{OH} = -12 mA	2.7	2.2	—	
					I _{OH} = -18 mA	3.0	2.4	—	
					I _{OH} = -24 mA	3.0	2.2	—	
	L-level	V _{OL}			I _{OL} = 100 μA	2.3 to 3.6	—	0.2	
					I _{OL} = 8 mA	2.3	—	0.6	
					I _{OL} = 12 mA	2.7	—	0.4	
					I _{OL} = 16 mA	3.0	—	0.4	
					I _{OL} = 24 mA	3.0	—	0.55	
Input leakage current		I _{IN}	V _{IN} = 0 to 5.5 V		2.3 to 3.6	—	±5.0	μA	
3-state output OFF state current		I _{OZ}	V _{IN} = V _{IH} or V _{IL} V _{OUT} = 0 to 5.5 V		2.3 to 3.6	—	±5.0	μA	
Power-off leakage current		I _{OFF}	V _{IN} /V _{OUT} = 5.5 V		0	—	10.0	μA	
Quiescent supply current		I _{CC}	V _{IN} = V _{CC} or GND		2.3 to 3.6	—	20.0	μA	
			V _{IN} /V _{OUT} = 3.6 to 5.5 V		2.3 to 3.6	—	±20.0		
Increase in I _{CC} per input		ΔI _{CC}	V _{IH} = V _{CC} - 0.6 V		2.3 to 3.6	—	500		

AC Characteristics (Ta = -40 to 85°C)

Characteristics	Symbol	Test Condition	V _{CC} (V)		Min	Max	Unit
				CL(pF)			
Maximum clock frequency	f _{max}	Figure 1, Figure 2	2.5 ± 0.2	30	—	—	MHz
			2.7	50	—	—	
			3.3 ± 0.3	50	170	—	
Propagation delay time (CK-Q)	t _{pLH} t _{pHL}	Figure 1, Figure 2	2.5 ± 0.2	30	1.5	7.4	ns
			2.7	50	1.5	6.5	
			3.3 ± 0.3	50	1.5	6.2	
3-state output enable time	t _{pZL} t _{pZH}	Figure 1, Figure 3	2.5 ± 0.2	30	1.5	7.9	ns
			2.7	50	1.5	6.3	
			3.3 ± 0.3	50	1.5	6.1	
3-state output disable time	t _{pLZ} t _{pHZ}	Figure 1, Figure 3	2.5 ± 0.2	30	1.5	7.2	ns
			2.7	50	1.5	6.2	
			3.3 ± 0.3	50	1.5	6.0	
Minimum pulse width (CK)	t _w (H) t _w (L)	Figure 1, Figure 2	2.5 ± 0.2	30	3.5	—	ns
			2.7	50	3.0	—	
			3.3 ± 0.3	50	3.0	—	
Minimum setup time	t _s	Figure 1, Figure 2	2.5 ± 0.2	30	3.0	—	ns
			2.7	50	2.5	—	
			3.3 ± 0.3	50	2.5	—	
Minimum hold time	t _h	Figure 1, Figure 2	2.5 ± 0.2	30	2.0	—	ns
			2.7	50	1.5	—	
			3.3 ± 0.3	50	1.5	—	
Output to output skew	t _{osLH} t _{osHL}	(Note)	2.5 ± 0.2	30	—	—	ns
			2.7	50	—	—	
			3.3 ± 0.3	50	—	1.0	

Note: Parameter guaranteed by design.
 (t_{osLH} = |t_{pLHm} - t_{pLHn}|, t_{osHL} = |t_{pHLm} - t_{pHLn}|)

Dynamic Switching Characteristics (Ta = 25°C, input: t_r = t_f = 2.5 ns, R_L = 500 Ω)

Characteristics	Symbol	Test Condition	V _{CC} (V)		Typ.	Unit
Quiet output maximum dynamic V _{OL}	V _{OLP}	V _{IH} = 2.5 V, V _{IL} = 0 V, C _L = 30pF	2.5	0.6	V	
		V _{IH} = 3.3 V, V _{IL} = 0 V, C _L = 50pF	3.3	0.8		
Quiet output minimum dynamic V _{OL}	V _{OLV}	V _{IH} = 2.5 V, V _{IL} = 0 V, C _L = 30pF	2.5	0.6	V	
		V _{IH} = 3.3 V, V _{IL} = 0 V, C _L = 50pF	3.3	0.8		

Capacitive Characteristics (Ta = 25°C)

Characteristics	Symbol	Test Condition	V _{CC} (V)	Typ.	Unit
Input capacitance	C _{IN}	—	3.3	7	pF
Output capacitance	C _{OUT}	—	3.3	8	pF
Power dissipation capacitance	C _{PD}	f _{IN} = 10 MHz (Note)	3.3	25	pF

Note: C_{PD} is defined as the value of the internal equivalent capacitance which is calculated from the operating current consumption without load.

Average operating current can be obtained by the equation:

$$I_{CC (opr)} = C_{PD} \cdot V_{CC} \cdot f_{IN} + I_{CC}/16 \text{ (per bit)}$$

AC Test Circuit

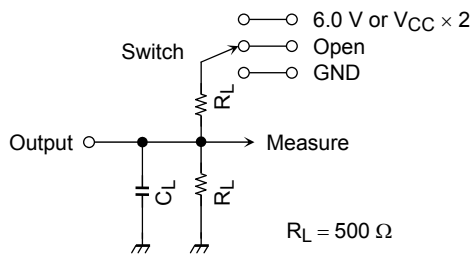

Parameter	Switch
t _{pLH} , t _{pHL}	Open
t _{pLZ} , t _{pZL}	6.0 V @V _{CC} = 3.3 ± 0.3 V V _{CC} × 2 @V _{CC} = 2.5 ± 0.2 V
t _{pHZ} , t _{pZH}	GND

Figure 1

AC Waveform

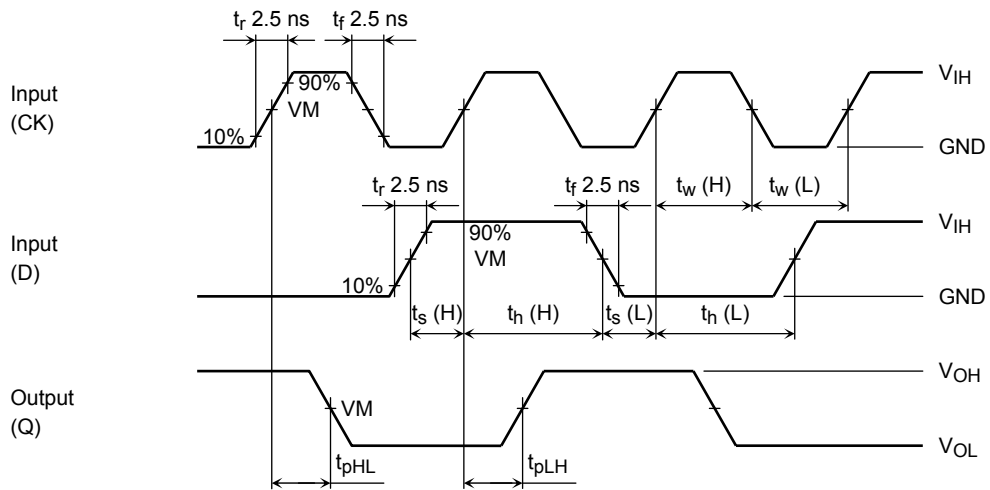

Figure 2 t_{pLH} , t_{pHL} , t_w , t_s , t_h

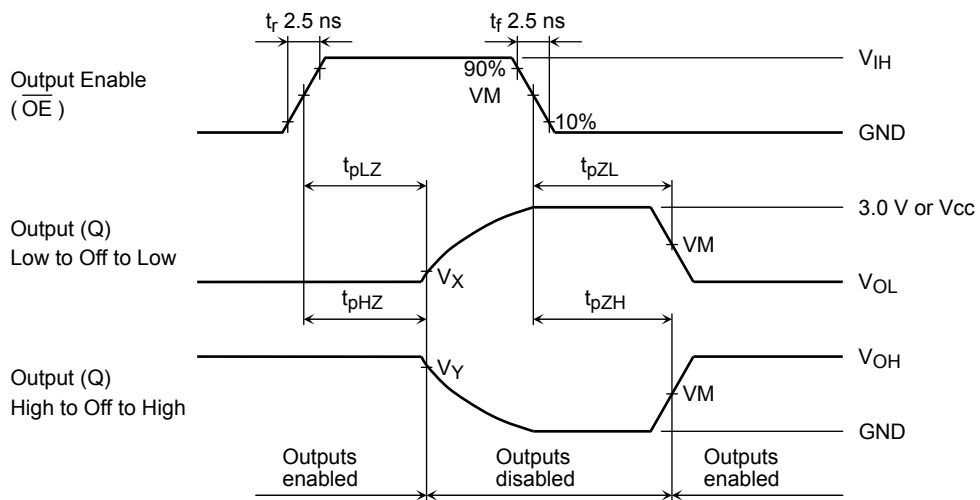

Figure 3 t_{pLZ} , t_{pHZ} , t_{pZL} , t_{pZH}

Symbol	V_{CC}		
	$3.3 \pm 0.3 \text{ V}$	2.7 V	$2.5 \pm 0.2 \text{ V}$
V_{IH}	2.7 V	2.7 V	V_{CC}
V_M	1.5 V	1.5 V	$V_{CC}/2$
V_X	$V_{OL} + 0.3 \text{ V}$	$V_{OL} + 0.3 \text{ V}$	$V_{OL} + 0.15 \text{ V}$
V_Y	$V_{OH} - 0.3 \text{ V}$	$V_{OH} - 0.3 \text{ V}$	$V_{OH} - 0.15 \text{ V}$

Package Dimensions

TSSOP48-P-0061-0.50A

Unit: mm

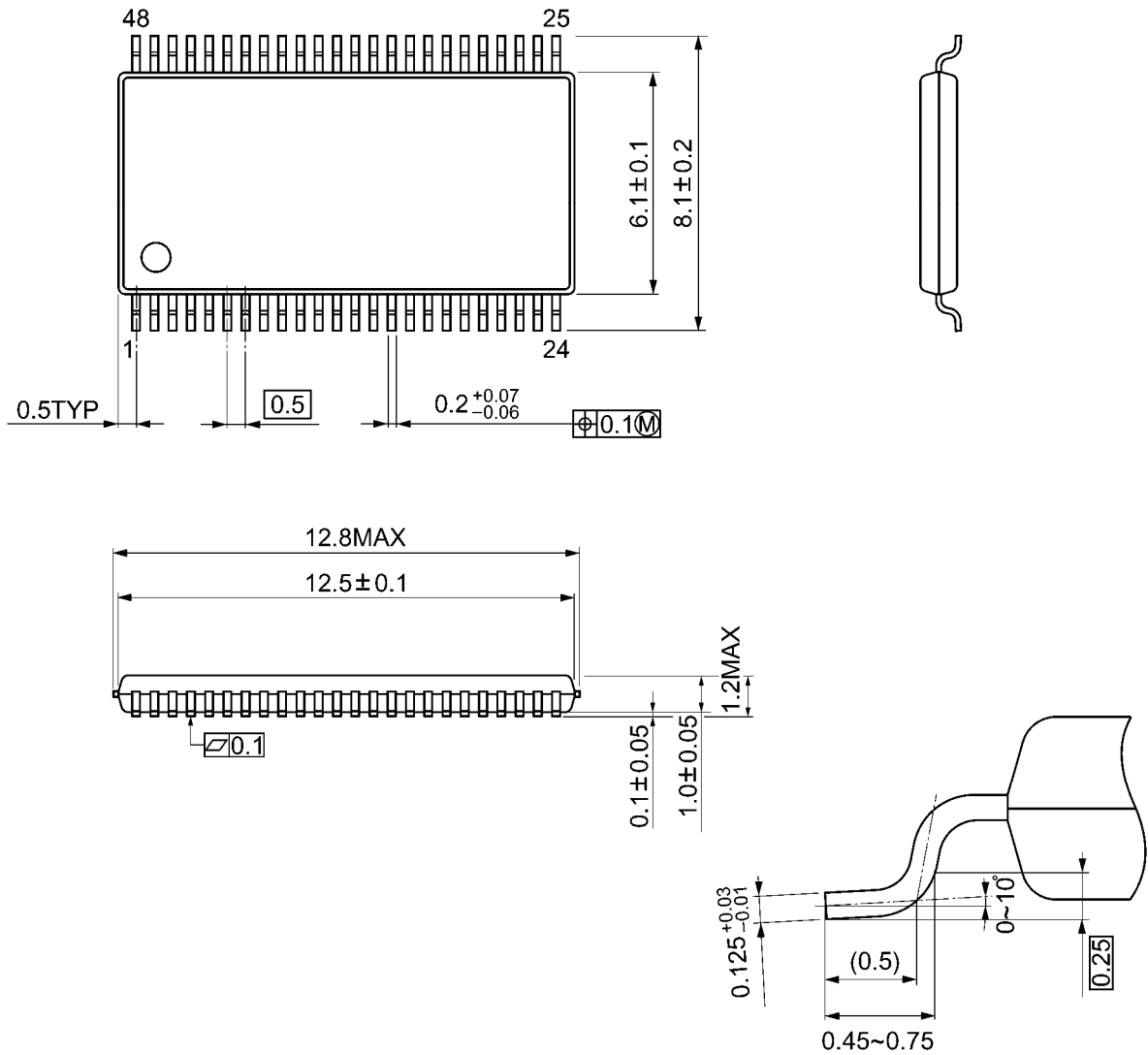

Weight: 0.25 g (typ.)

RESTRICTIONS ON PRODUCT USE

- Toshiba Corporation, and its subsidiaries and affiliates (collectively "TOSHIBA"), reserve the right to make changes to the information in this document, and related hardware, software and systems (collectively "Product") without notice.
- This document and any information herein may not be reproduced without prior written permission from TOSHIBA. Even with TOSHIBA's written permission, reproduction is permissible only if reproduction is without alteration/omission.
- Though TOSHIBA works continually to improve Product's quality and reliability, Product can malfunction or fail. Customers are responsible for complying with safety standards and for providing adequate designs and safeguards for their hardware, software and systems which minimize risk and avoid situations in which a malfunction or failure of Product could cause loss of human life, bodily injury or damage to property, including data loss or corruption. Before creating and producing designs and using, customers must also refer to and comply with (a) the latest versions of all relevant TOSHIBA information, including without limitation, this document, the specifications, the data sheets and application notes for Product and the precautions and conditions set forth in the "TOSHIBA Semiconductor Reliability Handbook" and (b) the instructions for the application that Product will be used with or for. Customers are solely responsible for all aspects of their own product design or applications, including but not limited to (a) determining the appropriateness of the use of this Product in such design or applications; (b) evaluating and determining the applicability of any information contained in this document, or in charts, diagrams, programs, algorithms, sample application circuits, or any other referenced documents; and (c) validating all operating parameters for such designs and applications. **TOSHIBA ASSUMES NO LIABILITY FOR CUSTOMERS' PRODUCT DESIGN OR APPLICATIONS.**
- Product is intended for use in general electronics applications (e.g., computers, personal equipment, office equipment, measuring equipment, industrial robots and home electronics appliances) or for specific applications as expressly stated in this document. Product is neither intended nor warranted for use in equipment or systems that require extraordinarily high levels of quality and/or reliability and/or a malfunction or failure of which may cause loss of human life, bodily injury, serious property damage or serious public impact ("Unintended Use"). Unintended Use includes, without limitation, equipment used in nuclear facilities, equipment used in the aerospace industry, medical equipment, equipment used for automobiles, trains, ships and other transportation, traffic signaling equipment, equipment used to control combustions or explosions, safety devices, elevators and escalators, devices related to electric power, and equipment used in finance-related fields. Do not use Product for Unintended Use unless specifically permitted in this document.
- Do not disassemble, analyze, reverse-engineer, alter, modify, translate or copy Product, whether in whole or in part.
- Product shall not be used for or incorporated into any products or systems whose manufacture, use, or sale is prohibited under any applicable laws or regulations.
- The information contained herein is presented only as guidance for Product use. No responsibility is assumed by TOSHIBA for any infringement of patents or any other intellectual property rights of third parties that may result from the use of Product. No license to any intellectual property right is granted by this document, whether express or implied, by estoppel or otherwise.
- **ABSENT A WRITTEN SIGNED AGREEMENT, EXCEPT AS PROVIDED IN THE RELEVANT TERMS AND CONDITIONS OF SALE FOR PRODUCT, AND TO THE MAXIMUM EXTENT ALLOWABLE BY LAW, TOSHIBA (1) ASSUMES NO LIABILITY WHATSOEVER, INCLUDING WITHOUT LIMITATION, INDIRECT, CONSEQUENTIAL, SPECIAL, OR INCIDENTAL DAMAGES OR LOSS, INCLUDING WITHOUT LIMITATION, LOSS OF PROFITS, LOSS OF OPPORTUNITIES, BUSINESS INTERRUPTION AND LOSS OF DATA, AND (2) DISCLAIMS ANY AND ALL EXPRESS OR IMPLIED WARRANTIES AND CONDITIONS RELATED TO SALE, USE OF PRODUCT, OR INFORMATION, INCLUDING WARRANTIES OR CONDITIONS OF MERCHANTABILITY, FITNESS FOR A PARTICULAR PURPOSE, ACCURACY OF INFORMATION, OR NONINFRINGEMENT.**
- Do not use or otherwise make available Product or related software or technology for any military purposes, including without limitation, for the design, development, use, stockpiling or manufacturing of nuclear, chemical, or biological weapons or missile technology products (mass destruction weapons). Product and related software and technology may be controlled under the Japanese Foreign Exchange and Foreign Trade Law and the U.S. Export Administration Regulations. Export and re-export of Product or related software or technology are strictly prohibited except in compliance with all applicable export laws and regulations.
- Please contact your TOSHIBA sales representative for details as to environmental matters such as the RoHS compatibility of Product. Please use Product in compliance with all applicable laws and regulations that regulate the inclusion or use of controlled substances, including without limitation, the EU RoHS Directive. TOSHIBA assumes no liability for damages or losses occurring as a result of noncompliance with applicable laws and regulations.