

TA76L431FB

2.495 V Adjustable High-Precision Shunt Regulators

These devices are adjustable high-precision shunt regulators whose output voltage (V_{KA}) can be set arbitrarily using two external resistors.

The devices have a precise internal reference voltage of 2.495 V, enabling them to operate at low voltage. In addition, they can be used as zener diodes to perform temperature compensation.

Features

- Precision reference voltage : $V_{REF} = 2.495 \text{ V} \pm 1.0\%$ ($T_j = 25^\circ\text{C}$)
- Adjustable output voltage: $V_{REF} \leq V_{OUT} \leq 19 \text{ V}$
- Minimum cathode current for regulation: $I_{Kmin} = 0.5 \text{ mA (max)}$
- Packages: Surface-mount S-Mini

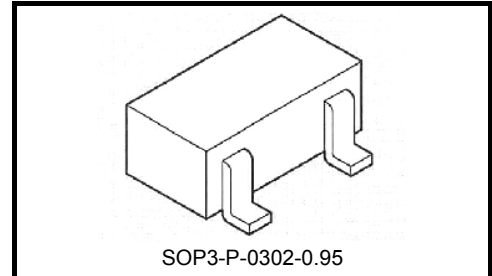

Weight: 0.012 g (typ.)

Pin Assignment/Marking

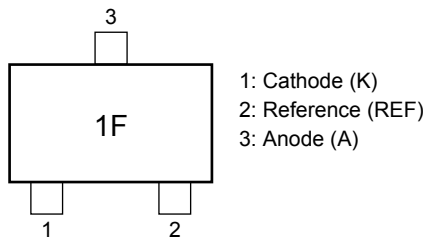

How to Order

Product No.	Package	Packing Type and Capacity
TA76L431FB(TE85L,F)	S-Mini(surface-mount type)	Embossed tape: 3000 pcs / reel

Functional Block Diagram

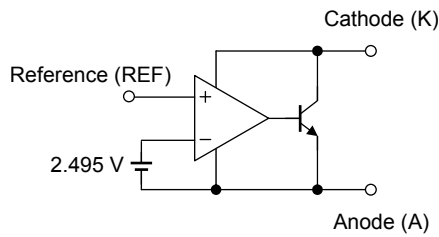

Circuit Symbol

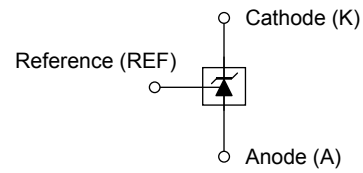

Typical Application Circuits

(1) 2.495 V Reference ($V_{KA} = V_{REF}$)

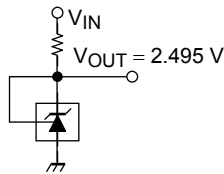

(2) Shunt Regulator ($V_{KA} > V_{REF}$)

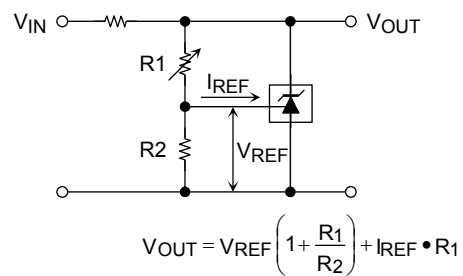

Usage Precautions

1. TA76L431FB
These products contain MOS elements. Please take care to avoid generating static electricity when handling these devices.
2. TA76L431FB
The oscillation frequency of these devices is determined by the value of the capacitor connected between the anode and the cathode.
When establishing maximum operating condition parameters, please derate the absolute maximum rating values specified in these datasheets so as to allow an operational safety margin.
Use of a laminated ceramic capacitor is recommended

Absolute Maximum Ratings (Ta = 25°C)

Characteristics	Symbol	Rating	Unit
Cathode voltage	V_{KA}	20	V
Cathode current	I_K	50	mA
Cathode-anode reverse current	$-I_K$	50	mA
Reference voltage	V_{REF}	7	V
Reference current	I_{REF}	50	μ A
Reference-anode reverse current	$-I_{REF}$	10	mA
Power dissipation	P_D	200 (Note 1)	mW
Thermal resistance	R_{th}	625 (Note 1)	$^{\circ}$ C/W
Operating junction temperature	T_{jopr}	-40 to 150	$^{\circ}$ C
Junction temperature	T_j	150	$^{\circ}$ C
Storage temperature	T_{stg}	-55 to 150	$^{\circ}$ C

Note 1: Glass epoxy substrate mounting: 30 mm × 30 mm × 0.8 mm (t) (Cu pad area 35 mm²)

Note 2: Using continuously under heavy loads (e.g. the application of high temperature/current/voltage and the significant change in temperature, etc.) may cause this product to decrease in the reliability significantly even if the operating conditions (i.e. operating temperature/current/voltage, etc.) are within the absolute maximum ratings and the operating ranges.

Please design the appropriate reliability upon reviewing the Toshiba Semiconductor Reliability Handbook ("Handling Precautions"/"Derating Concept and Methods") and individual reliability data (i.e. reliability test report and estimated failure rate, etc).

Operating Ranges

Characteristics	Symbol	Min	Typ.	Max	Unit
Cathode voltage	V_{KA}	V_{REF}	—	19	V
Cathode current	I_K	0.5	—	40	mA

Electrical Characteristics (Unless otherwise specified, Tj = 25°C, IK = 10 mA)

Characteristics	Symbol	Test Condition	Min	Typ.	Max	Unit
Reference voltage	V_{REF}	$V_{KA} = V_{REF}$	2.470	2.495	2.520	V
Deviation of reference input voltage over temperature	$V_{REF} (dev)$	$0^{\circ}\text{C} \leq T_j \leq 70^{\circ}\text{C}, V_{KA} = V_{REF}$	—	8	18	mV
Ratio of change in reference input voltage to the change in cathode voltage	$\Delta V_{REF}/\Delta V$	$V_{REF} \leq V_{KA} \leq 10\text{ V}$	—	0.8	2.4	mV/V
		$10\text{ V} \leq V_{KA} \leq 19\text{ V}$	—	0.8	2.0	
Reference input current	I_{REF}	$V_{KA} = V_{REF}$	—	0.6	3	μ A
Deviation of reference input current over temperature	$I_{REF} (dev)$	$0^{\circ}\text{C} \leq T_j \leq 70^{\circ}\text{C}, V_{KA} = V_{REF}, R_1 = 10\text{ k}\Omega, R_2 = \infty$	—	0.3	1.2	μ A
Minimum cathode current for regulation	I_{Kmin}	$V_{KA} = V_{REF}$	—	0.2	0.5	mA
Off-State cathode current	I_{Koff}	$V_{KA} = 19\text{ V}, V_{REF} = 0\text{ V}$	—	—	1.0	μ A
Dynamic impedance	$ Z_{KA} $	$V_{KA} = V_{REF}, f \leq 1\text{ kHz}, 0.5\text{ mA} \leq I_K \leq 40\text{ mA}$	—	0.2	0.5	Ω

Note on Electrical Characteristics

$T_j = 25^\circ\text{C}$ in the measurement conditions of each item is a regulation for where a pulse test is carried out and any drift in the electrical characteristic due to a rise in the junction temperature of the chip may be disregarded.

The deviation parameters $V_{REF}(\text{dev})$ and $I_{REF}(\text{dev})$ are defined as the maximum variation of the V_{REF} and I_{REF} over the rated temperature range ($T_j = 0$ to 70°C).

The average temperature coefficient of the V_{REF} is defined as:

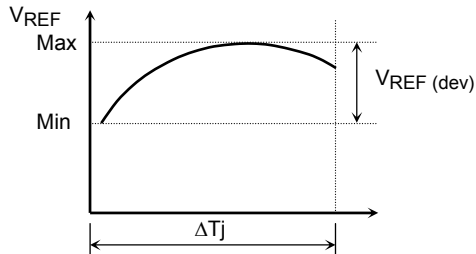

$$|\alpha V_{REF}| = \frac{\left(\frac{V_{REF}(\text{dev}) \times 10^6}{V_{REF} @ 25^\circ\text{C}} \right)}{\Delta T_j} \text{ (ppm/}^\circ\text{C)}$$

Application Circuit Example

Error amplification circuit for switching power supply

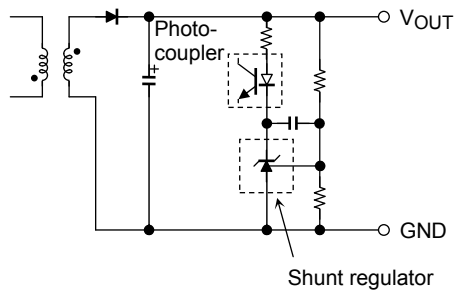

This circuit amplifies the difference between the switching power supply's secondary output voltage and the shunt regulator's reference voltage. It then feeds the amplified voltage back to the primary input voltage via the photocoupler.

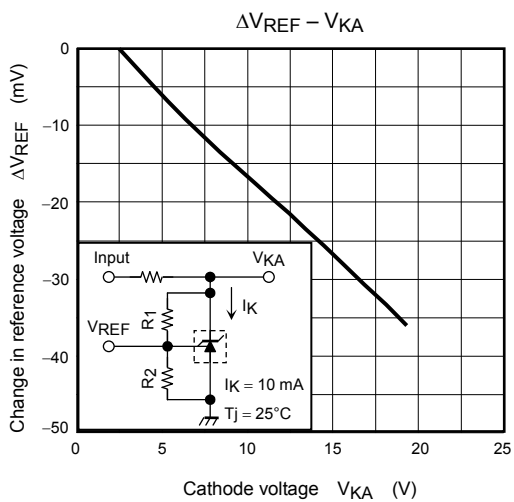
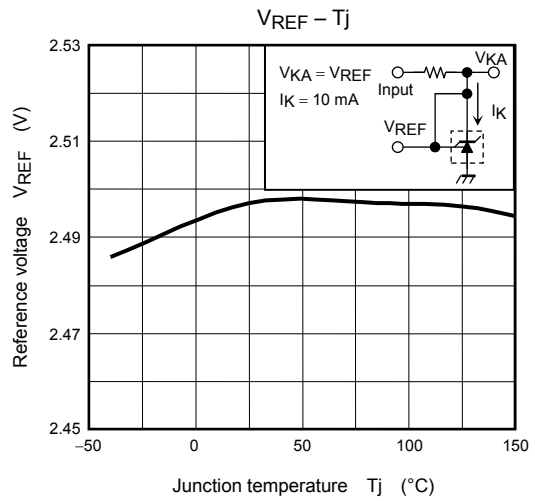
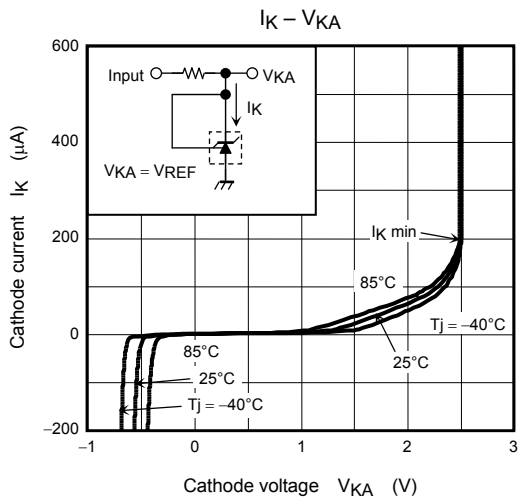
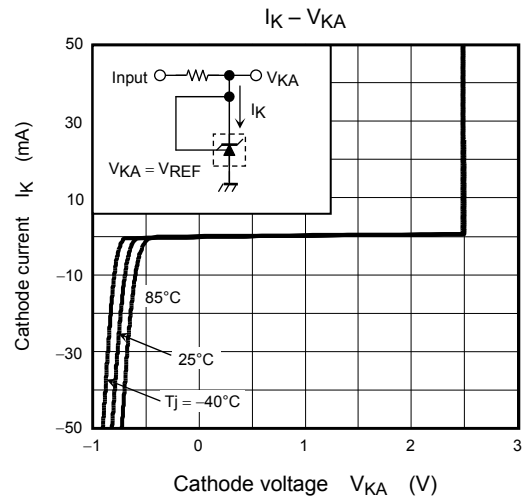
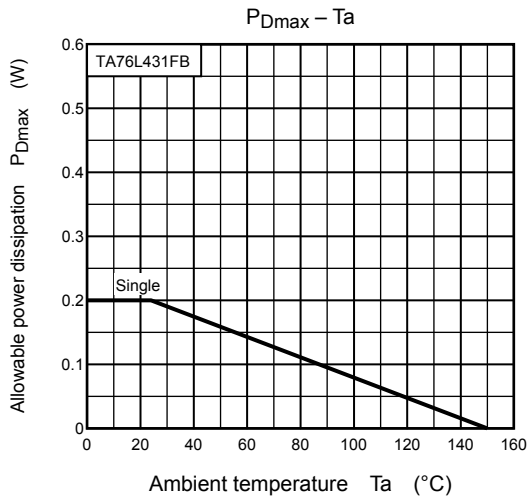

Package Dimensions

SOP3-P-0302-0.95

Unit : mm

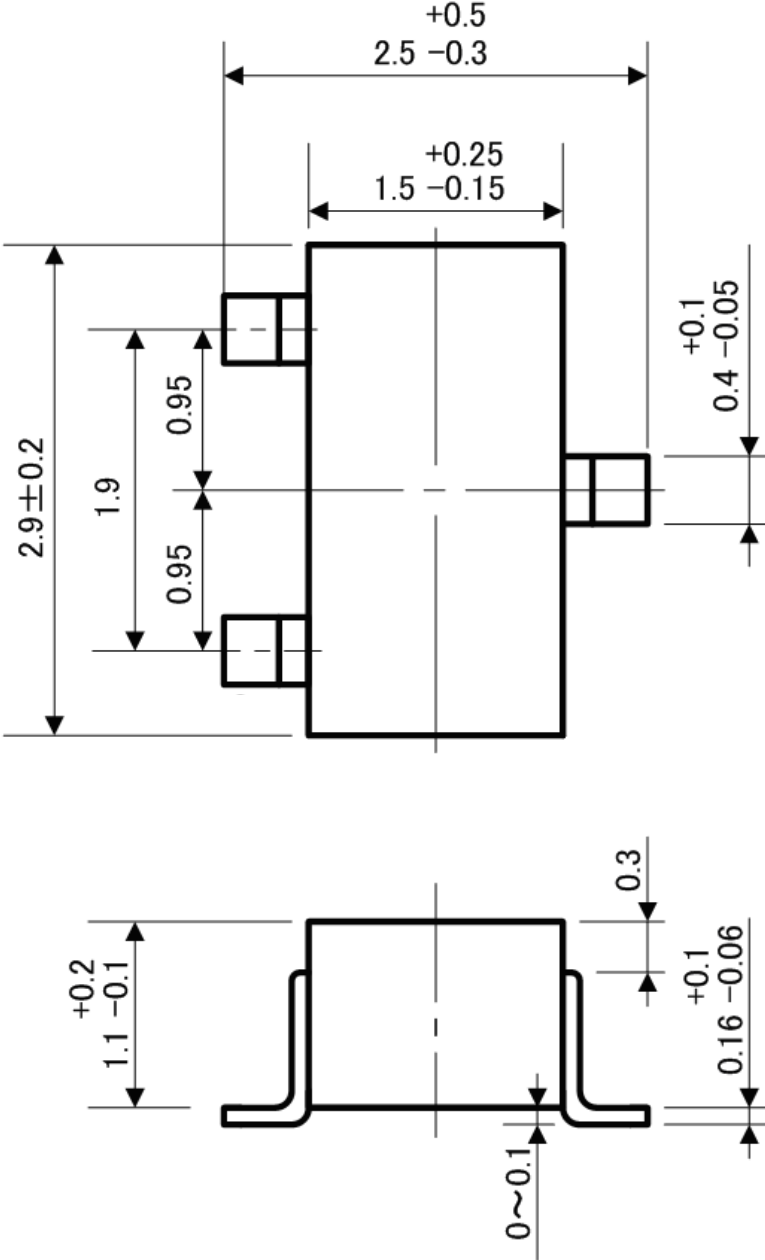

Weight: 0.012 g (typ.)

RESTRICTIONS ON PRODUCT USE

- Toshiba Corporation, and its subsidiaries and affiliates (collectively "TOSHIBA"), reserve the right to make changes to the information in this document, and related hardware, software and systems (collectively "Product") without notice.
- This document and any information herein may not be reproduced without prior written permission from TOSHIBA. Even with TOSHIBA's written permission, reproduction is permissible only if reproduction is without alteration/omission.
- Though TOSHIBA works continually to improve Product's quality and reliability, Product can malfunction or fail. Customers are responsible for complying with safety standards and for providing adequate designs and safeguards for their hardware, software and systems which minimize risk and avoid situations in which a malfunction or failure of Product could cause loss of human life, bodily injury or damage to property, including data loss or corruption. Before customers use the Product, create designs including the Product, or incorporate the Product into their own applications, customers must also refer to and comply with (a) the latest versions of all relevant TOSHIBA information, including without limitation, this document, the specifications, the data sheets and application notes for Product and the precautions and conditions set forth in the "TOSHIBA Semiconductor Reliability Handbook" and (b) the instructions for the application with which the Product will be used with or for. Customers are solely responsible for all aspects of their own product design or applications, including but not limited to (a) determining the appropriateness of the use of this Product in such design or applications; (b) evaluating and determining the applicability of any information contained in this document, or in charts, diagrams, programs, algorithms, sample application circuits, or any other referenced documents; and (c) validating all operating parameters for such designs and applications. **TOSHIBA ASSUMES NO LIABILITY FOR CUSTOMERS' PRODUCT DESIGN OR APPLICATIONS.**
- Product is intended for use in general electronics applications (e.g., computers, personal equipment, office equipment, measuring equipment, industrial robots and home electronics appliances) or for specific applications as expressly stated in this document. Product is neither intended nor warranted for use in equipment or systems that require extraordinarily high levels of quality and/or reliability and/or a malfunction or failure of which may cause loss of human life, bodily injury, serious property damage or serious public impact ("Unintended Use"). Unintended Use includes, without limitation, equipment used in nuclear facilities, equipment used in the aerospace industry, medical equipment, equipment used for automobiles, trains, ships and other transportation, traffic signaling equipment, equipment used to control combustions or explosions, safety devices, elevators and escalators, devices related to electric power, and equipment used in finance-related fields. Do not use Product for Unintended Use unless specifically permitted in this document.
- Do not disassemble, analyze, reverse-engineer, alter, modify, translate or copy Product, whether in whole or in part.
- Product shall not be used for or incorporated into any products or systems whose manufacture, use, or sale is prohibited under any applicable laws or regulations.
- The information contained herein is presented only as guidance for Product use. No responsibility is assumed by TOSHIBA for any infringement of patents or any other intellectual property rights of third parties that may result from the use of Product. No license to any intellectual property right is granted by this document, whether express or implied, by estoppel or otherwise.
- **ABSENT A WRITTEN SIGNED AGREEMENT, EXCEPT AS PROVIDED IN THE RELEVANT TERMS AND CONDITIONS OF SALE FOR PRODUCT, AND TO THE MAXIMUM EXTENT ALLOWABLE BY LAW, TOSHIBA (1) ASSUMES NO LIABILITY WHATSOEVER, INCLUDING WITHOUT LIMITATION, INDIRECT, CONSEQUENTIAL, SPECIAL, OR INCIDENTAL DAMAGES OR LOSS, INCLUDING WITHOUT LIMITATION, LOSS OF PROFITS, LOSS OF OPPORTUNITIES, BUSINESS INTERRUPTION AND LOSS OF DATA, AND (2) DISCLAIMS ANY AND ALL EXPRESS OR IMPLIED WARRANTIES AND CONDITIONS RELATED TO SALE, USE OF PRODUCT, OR INFORMATION, INCLUDING WARRANTIES OR CONDITIONS OF MERCHANTABILITY, FITNESS FOR A PARTICULAR PURPOSE, ACCURACY OF INFORMATION, OR NONINFRINGEMENT.**
- Do not use or otherwise make available Product or related software or technology for any military purposes, including without limitation, for the design, development, use, stockpiling or manufacturing of nuclear, chemical, or biological weapons or missile technology products (mass destruction weapons). Product and related software and technology may be controlled under the Japanese Foreign Exchange and Foreign Trade Law and the U.S. Export Administration Regulations. Export and re-export of Product or related software or technology are strictly prohibited except in compliance with all applicable export laws and regulations.
- Please contact your TOSHIBA sales representative for details as to environmental matters such as the RoHS compatibility of Product. Please use Product in compliance with all applicable laws and regulations that regulate the inclusion or use of controlled substances, including without limitation, the EU RoHS Directive. TOSHIBA assumes no liability for damages or losses occurring as a result of noncompliance with applicable laws and regulations.